

SIEMENS



Synco™, Synco™ living
Web server OZW772... V6.0
Commissioning instructions

OZW772.01
OZW772.04
OZW772.16
OZW772.250

Siemens Switzerland Ltd
Building Technologies Division
International Headquarters
Gubelstrasse 22
6301 Zug
Switzerland
Tel. +41 41-724 24 24
www.siemens.com/buildingtechnologies

© Siemens Switzerland Ltd, 2009
Subject to change

Table of contents

1	Overview	7
1.1	Introduction.....	7
1.2	Web Server display and operating elements.....	9
1.3	User interface	10
1.3.1	User levels.....	11
1.4	Symbols, notations, abbreviations.....	12
1.4.1	Symbols	12
1.4.2	Notations	13
1.4.3	Abbreviations.....	13
2	Commissioning.....	14
2.1	Prerequisites.....	14
2.2	Getting started	15
2.2.1	Turn on Web Server.....	15
2.2.2	Log into Web Server	16
2.3	Administer user accounts.....	18
2.4	Create device web pages.....	20
2.5	Web Server settings.....	23
2.5.1	Operating page settings "Time of day/date".....	23
2.5.2	Operating page "Faults current"	24
2.5.3	Operating page "Settings".....	24
2.5.3.1	Web Server.....	24
2.5.3.2	Time of day/date	24
2.5.3.3	Communication.....	25
2.5.3.4	Message receivers.....	28
2.5.3.5	System report.....	31
2.5.3.6	Consumption data	32
2.5.3.7	Energy indicator.....	33
2.5.3.8	Trend	34
2.5.3.9	Faults.....	34
2.5.3.10	Texts.....	35
2.5.4	Operating page "Device information".....	35
2.6	Commission network components.....	36
2.6.1	Access via portal.....	36
2.6.2	Access via a local area network (LAN).....	36
2.6.3	Access via direct connection	37
2.7	Functional check.....	39
2.8	Additional settings.....	41
2.9	Final steps	42
2.9.1	Check faults.....	42
2.9.2	Final steps on Web Server.....	42
2.10	Supply state.....	43
2.11	Software updates.....	43
3	Remote access via portal	44
3.1	Set up access via portal	44
3.1.1	Portal and plant roles.....	48
3.2	Prevent connection to portal.....	48

4	Operate using a web browser	49
4.1	Overview	49
4.2	Operate the plant.....	51
4.2.1	Operate Synco device.....	51
4.2.2	Operate Web Server.....	51
4.2.3	Web Server diagnostics	53
4.3	Faults	56
4.3.1	Overview	56
4.3.2	Device faults.....	56
4.4	File transfer	58
4.5	Operation with ACS790.....	62
5	Visualize plants	63
5.1	Overview	63
5.2	Example of a plant web page	64
5.3	Plant web page features	65
5.4	Toolbar	66
5.5	Import web-capable plant diagrams.....	67
5.6	Create own plant web pages.....	69
6	Record consumption data.....	73
6.1	Consumption data file	74
6.1.1	Main areas for consumption data file.....	74
6.1.2	Meter data in detail	75
6.2	Time ratios.....	76
6.3	Send consumption data file.....	79
7	"Energy indicator" function	80
7.1	Introduction.....	80
7.1.1	Function description.....	80
7.1.2	KNX bus topology	81
7.1.3	Synco product range.....	82
7.1.4	Navigation and device web pages	83
7.2	"Energy indicator" function levels	84
7.2.1	"Plant" level	84
7.2.2	"Partial plants" level	85
7.2.3	"Data points" level.....	86
7.2.4	Number of "Monitored data points"	87
7.2.5	"Energy indicator" visibility	88
7.2.6	Summary display "Energy indicator" for a plant	89
7.3	"Energy indicator" commissioning function	90
7.3.1	Commissioning notes.....	90
7.3.2	Start "Energy indicator" function.....	90
7.3.3	Estimated processing time.....	91
7.3.4	Deactivating "Data point monitoring"	91
7.3.5	Activating "Data point monitoring"	93
7.4	Dialog boxes, data points, and "Green limits"	95
7.4.1	General dialog boxes.....	95
7.4.2	Dialog boxes with numeric data points	96
7.4.3	Dialog boxes with enumeration data points	97
7.4.4	Dialog boxes with variable unit data points.....	98
7.4.5	Dialog boxes for data points with manually set value.....	99

7.4.6	User groups "Service" and "End user"	100
7.5	E-mail with "Energy indicator" for the plant	101
7.5.1	E-mail receiver configuration	101
7.5.2	Mail inbox	102
7.5.3	E-mail contents	103
7.6	Exceptions	104
8	Communications.....	105
8.1	Remote operation	105
8.1.1	Access via portal	105
8.1.2	Access via Local area network (LAN)	106
8.1.3	Access via direct connection	110
8.2	Messages via e-mail	114
9	Trend functions.....	119
9.1	Overview	119
9.2	Define trend	120
9.2.1	Define trend via web	120
9.2.2	Restriction to bus load	124
9.2.3	Reset trend definition	124
9.2.4	Add trend data points	125
9.2.5	Manage trend RAM	126
9.3	Send trend data by e-mail	127
9.3.1	Configure E-mail receiver	127
9.3.2	Sent transmission options per trend channel	128
9.3.3	E-mail content and appendix	130
9.4	Download trend file via web	131
9.5	Graphical trend display	133
9.6	Import/export trend definitions	134
9.7	ACS Trend	137
9.7.1	ACS offline trend compatibility	137
9.7.2	ACS trend bus load	138
10	KNX S-Mode.....	139
10.1	Configuration in KNX S-Mode	141
10.2	Operation KNX S-mode	156
11	Appendix.....	159
11.1	General notes	159
11.2	Diagnostics	159
11.2.1	Web Server fault codes	159
11.2.2	Windows Commander	160
11.3	Communications	161
11.3.1	Internet protocol	161
11.3.2	Free e-mail account providers	161
11.3.3	Install RNDIS driver	162
11.3.4	Alternative network configuration	164
11.4	Glossary of Ethernet and Internet terms	165
Index	172

1 Overview

1.1 Introduction

Type summary

Type designation	Max. number of devices on KNX bus
OZW772.01	1 device
OZW772.04	4 devices
OZW772.16	16 devices
OZW772.250	250 devices

Document contents

The document describes commissioning and operating the Web Server OZW772...

In this edition "Web-Server OZW772..., V6.0" the following extensions were added:

- New default password and minimum password strength. See sections 2.2.2 and 2.5.3.1
- Change to absolute timeout. See Sections 2.5.3.3 and 4.1
- Response to incorrect login. See Section 4.1
- Response to communication problems for trend queries. See Section 9.2.1
- Synchronization of trends. See Sections 9.2.1 and 9.3.2
- New function "Trend graphic". See Section 9.5
- Group Monitoring is supported. See Section 10
- Additional fault codes. See Section 11.2
- Continuous access. See Section 11.3.1

The latest edition is available on www.siemens.com/ozw772-manual.

Focus on web browser operation

The ACS790 PC software can also be used to commission and operate the Web Server OZW772... To simplify reading, this document focuses on commissioning and operating via web browser.

Important notes



The symbol to the right identifies special safety notes and warnings.

Ignoring this type of note may result in device damage and personal injury.

Safety / Product liability

- Devices may only be used in building technical plants and for the described applications only. Comply with all local regulation (installation, etc.).
- Disconnect the power and immediately replace a defective or obviously damaged device.
- Do not open the device. Failure to comply will invalidate any warranty claims.
- The technical data are provided solely for use with Siemens bus devices. The user ensures the functionality of operation when using third-party devices not expressly mentioned here. Siemens assumes no responsibility for service and warranty under these circumstances.

Intended use

Trouble-free and safe product operation presupposes transport, storage, mounting, installation, and commissioning as intended as well as careful operation.

Disposal

The devices are considered electronics devices for disposal in terms of European Directive 2012/19/EU and may not be disposed of as domestic waste.

- Dispose of the device via the proper channels.
- Comply with all local and currently applicable laws and regulations.

1.2 Web Server display and operating elements

Overview

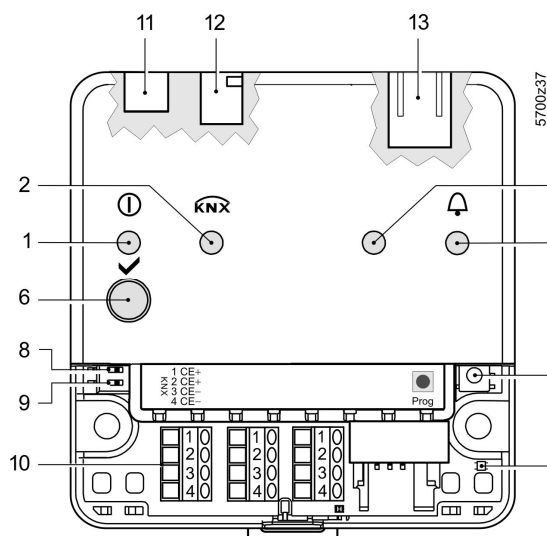

Pos	Designation
1	LED ⓘ Operation, portal connection display and "Energy indicator"
2	LED KNX
3	LED field bus 2 (reserve)
4	LED fault ⓘ
5	LED addressing mode
6	Remote button ✓
7	Addressing mode button Prog
8	"Message suppression" switch
9	Switch 2 (no function)
10	KNX bus connection terminals
11	Operating voltage connection
12	USB connection Mini-B
13	Ethernet connection, RJ45 plug

LED displays

- | | |
|--------------------------------|---|
| 1 ⓘ (red/green/orange) | <ul style="list-style-type: none"> • Dark No operating voltage DC 24 V • Steady red Web Server starts operating system • Flashing red Web Server starts application • Steady green Web Server operational, "Energy indicator" = "Green leaf" • Steady orange Web Server operational, "Energy indicator" = "Orange leaf" • Flashing green / orange Web Server operational, connected to portal (LED 0.8 s on, 0.2 s off) |
| 2 KNX (green) | <ul style="list-style-type: none"> • Dark No bus power • Lit KNX operational • Flashing Communication on KNX |
| 3 Field bus 2 (reserve) | <ul style="list-style-type: none"> • Dark No function |
| 4 Fault ⓘ (red) | <ul style="list-style-type: none"> • Dark No fault (normal operating state) • Lit Acknowledged fault • Flashing Unacknowledged fault |
| 5 Addressing mode (red) | <ul style="list-style-type: none"> • Dark KNX addressing mode off • Lit KNX addressing mode on |

Operating buttons

- | | |
|--------------------------|---|
| 6 Remote button ✓ | <ul style="list-style-type: none"> • Short (< 2 s) Acknowledges fault message • Long (> 6 s) Sends system report to fault e-mail Receivers (not to consumption data and "Energy indicator" Receivers) |
|--------------------------|---|

- | | |
|-------------------------------|--|
| 7 Addressing mode Prog | <ul style="list-style-type: none"> • Short (< 2 s) Press once: KNX addressing mode on
Press again: KNX addressing mode off |
|-------------------------------|--|

- | | |
|---|---|
| Button combinations
✓ and Prog | <ul style="list-style-type: none"> • Long (> 6 s) Simultaneously pressing the buttons ✓ and Prog restores defaults
 ⓘ All configuration data and settings are reset. The device list, plant diagrams, and unsent messages are deleted. History data is not deleted. |
|---|---|

Switches

- | | |
|---|---|
| 8 <input type="checkbox"/> Message suppression | <ul style="list-style-type: none"> • Position ON <input type="checkbox"/> Sending messages is suppressed • Position OFF <input type="checkbox"/> Sending messages permitted |
| 9 <input type="checkbox"/> DIP switch 2 | <ul style="list-style-type: none"> • Switch settings No function |

1.3 User interface

A web browser is used to access the user interface for the Web Server.

- The Web Server provides text-based operation of the Web Server and connected Synco devices as a standard (Section 4).
- You can also set up visualized operation (Section 5).

The following describes the display areas for the text-based standard user interface (display areas for visualization are outlined in Section 5).

The main window is sub-divided into various areas.

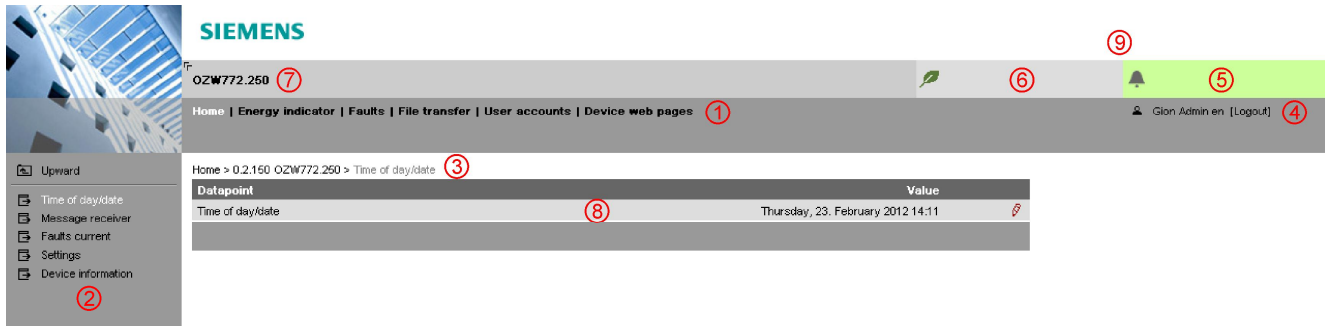

① Primary navigation

The following functions are selected via primary navigation:

Home	Menu-based plant and device operation.
Energy indicator	Display and operate "Energy indicator" data points. (displayed only is controller is connected with an Energy indicator)
Faults	Display system faults.
File transfer	Download consumption data and event history, upload documents, logos and system definitions.
User accounts	User administration.
Device web pages	Create device list and operating pages.

② Secondary navigation

Device operation (via home) queries devices and their operating pages via secondary navigation (menu tree). As of OZW-Version 5.0, KNX pages defined in ETS are displayed here too.

③ Command sequence

The path displays the workflow starting at the main menu to the open operating page. Simply click at any point on the path to return to that location.

④ User

This field shows the currently logged-in user. Clicking [Logout] ends the current session. The session remains active until logout. When connecting via the portal the ☁ symbol is displayed instead of the 👤 symbol and the user's email address is displayed rather than the user name.

⑤ Plant state fault

The "Plant state fault" field is displayed permanently:

- Green field: No fault
- Red field: Plant fault

Click the "Plant state fault" field to display all faults in the plant.

⑥ Plant state Energy indicator

The "Plant state Energy indicator" field is displayed permanently:

- Green leaf: All "Energy indicator" data points are always within their "green limits", i.e. "within the green/allowed range".
- Orange leaf: One or multiple "Energy indicator" data points are outside their "green limits"

Clicking the "Plant state Energy indicator" field opens the "Energy indicator" function.

- ⑦ **Plant name** Displays plant name as entered.
- ⑧ **Display** The display range displays content corresponding to the selected function via primary and secondary navigation.
- ⑨ **Logo area** Shows Logo 1 and Logo 2.

1.3.1 User levels

Displays and operates based access level for the logged on user:

End user

- Operate end user data
- Operating of KNX S-Mode devices
- Fault overview
- Administer own user account



Service

Same as end user. In addition:

- Operate service data
- Documents, message history

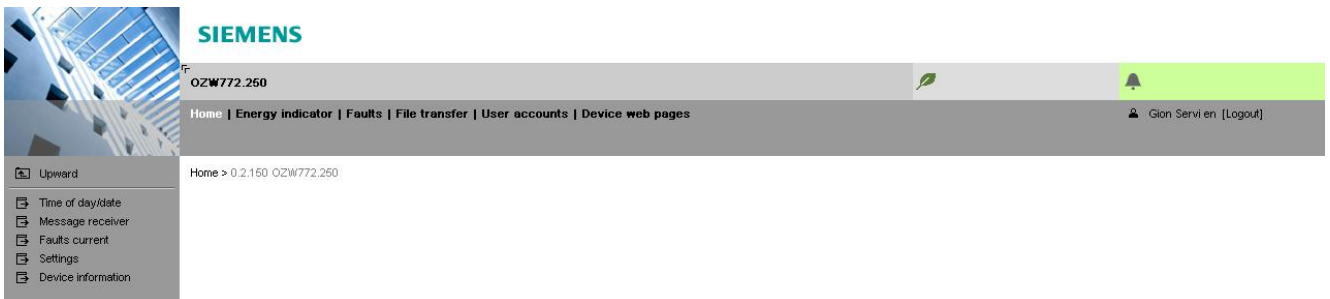

Administrator

Same as service. In addition:



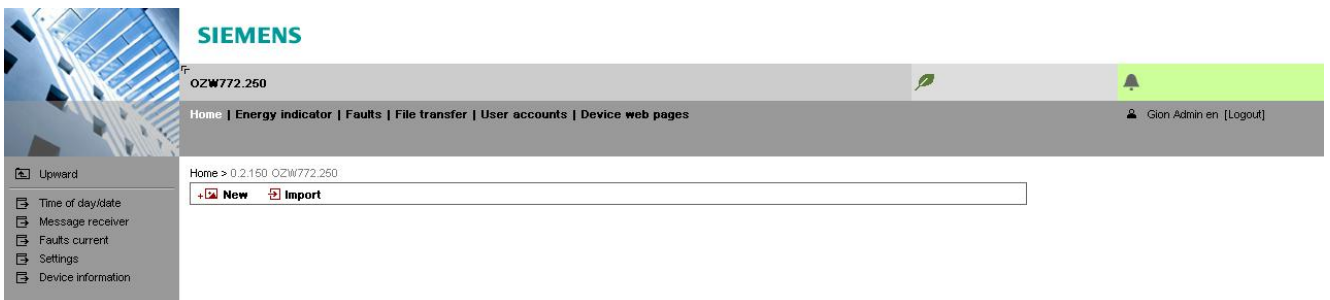



































- Create device list and web pages
- The toolbar to create plant web pages
- Administer all user accounts



1.4 Symbols, notations, abbreviations

1.4.1 Symbols

Symbols

Symbol	Meaning
	Data point at the service level
	Data point at the end user level
	Read/write data point; the setting value can be changed
	Read-only data point; the value cannot be changed
	Link to entry field
	Delete object
	Checkbox
	Selection box
	Calendar
	Arrows to incrementally adjust values
	Adjustment tab
	Arrow to display sort order
	Up
	File upload (to Web Server)
	File download (from Web Server)
	Export file
	Import file
	Add data point
	Move/sort data point
	Start trending
	Stop trending
	Generate trend graph
	Calendar for selecting the date
	Safety note, intended to protect against misuse
	Always observe/follow
	Note; important information
	Network connection
	Link to device
	User connected locally or via direct connection (fixed or dynamic IP address).
	User connected via portal.
	Message history
	System definitions
	Logos
	Switch over displays: Full view, partial view
	Fault indication: Green field = no fault; red field = fault (alarm)
	"Green leaf"
	"Orange leaf"
	"Grey leaf"

1.4.2 Notations

Path indications

Paths are printed as follows:

- Web Server: Home > 0.2.150 OZW772.xx > Settings > Time of day/date.
- PC: Start > Settings > Network connections > Local Area Connection.

OZW772.xx stands for: OZW772.01 or
 OZW772.04 or
 OZW772.16 or
 OZW772.250

IP address, domains

Enter in the browser address line:

- IP address: 192.168.2.10
- Domain: www.siemens.com
- Portal: <https://www.siemens-syncoic.com>

Buttons

Buttons depicted as follows: [Add]

1.4.3 Abbreviations

Abbreviations

Auto MDI-X	Auto Medium Dependent Interface – Crossed.
COV	Change of value
ECA	Energy Cost Allocation
HTTP	Hyper Text Transfer Protocol
HTTPS	Hyper Text Transfer Protocol Secure
IP	Internet Protocol
KNX	Konnex
LAN	Local Area Network
NAT	Network Address Translation
PAT	Port and Address Translation
RNDIS	Remote Network Driver Interface Specification
SMTP	Simple Mail Transfer Protocol
STP	Shielded Twisted Pair
TCP	Transmission Control Protocol
TLS	Transport Layer Security
UPnP	Universal Plug and Play
USB	Universal Serial Bus
UTP	Unshielded Twisted Pair
Web API	Web Application Programming Interface

The glossary, Section 11.4, contains detailed explanations of terms and abbreviations.

2 Commissioning

This section describes how to commission the Web Server.

2.1 Prerequisites

General

The following conditions must be met to commission the Web Server:

- The Web Server is mounted and wired (see Installation instructions, G5701).
- The connected KNX devices are commissioned.
- The KNX devices have a valid KNX address [1...253] are operating.
Note: Web Servers are delivered with KNX address 150. As a result KNX address range [1...253], except for 150, applies to all other devices.
- Bus power supply to the KNX bus is available.
- The Web Server or another KNX device is the clock master on KNX.

Notes



- The Web Server automatically receives its IP address from the router when the DHCP client is switched on. The address without router is: 192.168.2.10 (factory setting, see Section 8.1.2)
- Connecting a SmartPhone App to a Web Server makes sense only after the Web Server is fully commissioned.

Portal commissioning requirements

The following is required to commission the Web Server on the portal:

- The Web Server is connected to the Internet

The Web Server automatically registers on the portal.

The operation LED starts to flash green / orange as soon as the Web Server is connected to the portal.

Local commissioning requirements without portal

The following is required to commission the Web Server:

- A PC/laptop and a web browser commission Web Server via an USB interface. The RNDIS driver must be installed to connect via USB. IP address USB: 192.168.250.1 (cannot be changed). The address range 192.168.250.1 - 192.168.250.255 cannot be used for Ethernet and is reserved exclusively for USB.
- The RNDIS driver is automatically installed when connecting via USB if the PC/laptop is connected to the Internet (as long as the Microsoft online update service is enabled). The RNDIS driver can be installed manually if there is no connection to the Internet (see Section 11.3.3)
- The RNDIS is supplied on the Web Server at <http://<IP-Adresse>/drivers/>

Operating notes





- To navigate, always start with primary navigation, then use the secondary navigation to select the desired menu item.
- Return: Click "Upward" or navigate via the path or primary navigation.

2.2 Getting started

2.2.1 Turn on Web Server

Turn on Web Server

Connect the Web Server to the power supply and connect it to the PC:

1. Connect power supply to turn on power on Web Server. The Web Server is operational, when the green  LED is lit.
2. Check additional displays:
 - LED 
Green light if the KNX bus power supply is available. Check KNX bus wiring and setting for bus power supply on the KNX devices if no bus power supply is available.
 - LED 
Dark if no fault pending. You can troubleshoot pending faults later (see Section 4.3).
3. Plug the supplied USB cable into the Web Server and the PC and start up the PC. The PC recognizes the Web Server as a USB device. Otherwise, the RNDIS is still not installed.

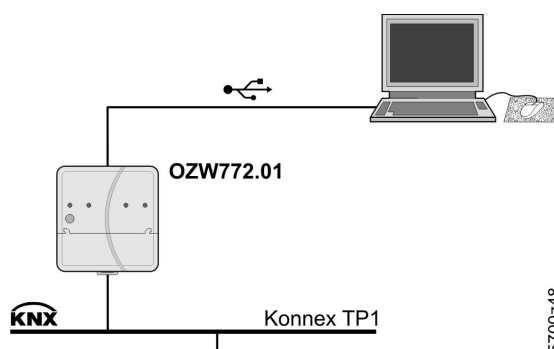

4. The RNDIS driver is installed automatically if the PC is connected to the Internet and no RNDIS driver is installed as long as the Microsoft online update is enabled. Follow the instructions for the installation program.

Note

 You can also manually setup the RNDIS driver (see Section 11.3.3).

2.2.2 Log into Web Server

Log on

A PC with USB interface and web browser is used to commission the Web Server.

1. Start web browser.
2. In the address line, enter the USB IP address (192.168.250.1).

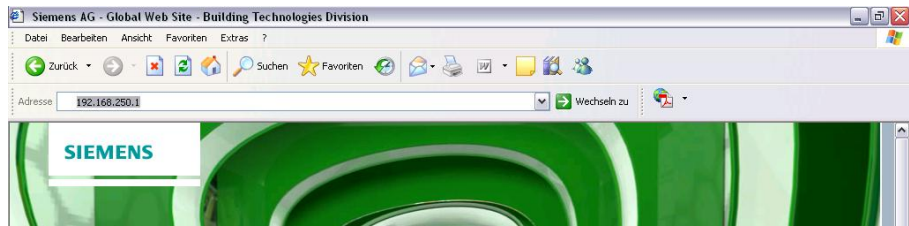

3. First time Login
 - User name Administrator
 - Password to V5.2(Passw0rd): *Passw0rd*
 - Password as of V6.0 (Passw0rd): *Passw0rd.1*

Login	
User name	<input type="text" value="Administrator"/>
Password	<input type="password" value="••••••••"/>
<input type="button" value="Login"/>	

4. Click [Login] to finish.
5. After logging on the first time, the dialog box is displayed to define a new password.

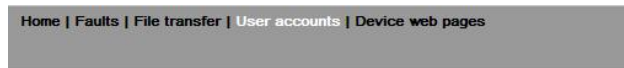

Change user	
User name	<input type="text" value="Administrator"/>
Password	<input type="text"/>
Repeat password	<input type="text"/>
Description (optional)	<input type="text"/>
E-mail address (optional)	<input type="text"/>
Language	<input type="text" value="English"/>
<input type="button" value="OK"/>	

Important note



- **A new password must** be defined the first time you log in (you can also change the language).
- You cannot exit the dialog box if you do not define a new password (i.e. not equal to "Passw0rd" or "Passw0rd.1") and the following note is displayed:



- The following message is displayed if you fail to fill out all required fields:

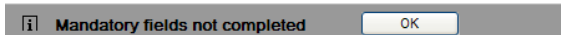

Password and user name

Observe capitalization when entering the password.
The message "Entry incorrect" is displayed when entering an incorrect password.

Minimum password strength

The password strength is checked when entering the password and a progress bar displayed. The bar is orange is the password is weak. It changes to green as soon as the password is strong enough.

The following conditions must be met for a secure password:

- Minimum password length of 8 characters
- At least 1 capital letter
- At least 1 lowercase letter
- At least 1 number
- At least 1 special character

2.3 Administer user accounts

Administer user accounts

The "User Accounts" ("User accounts") menu changes the administrator password at delivery and sets up additional user accounts.

Note



The user account settings equally apply to access via Smartphone app and other applications via Web API.

User name	Description (optional)	E-mail address (optional)	Language	User group
Administrator			English	Administrator

Change administrator data

Procedure:

1. Click red pencil
The "Change user" dialog box opens.

Change user	
User name	Administrator
Password	
Repeat password	
Description (optional)	Muster Heiztechnik
E-mail address (optional)	muster@heiztechnik.ch
Language	Deutsch
OK Cancel	

2. Change administrator data:
 - Password
 - Repeat Password
 - Description (optional)
 - E-mail address (optional)
 - Language: English
3. Close with [OK]

Add a new user

Procedure:

1. Click [Add]
The "Add user" dialog box opens.

Add user	
User name	Mike Sample
Password
Repeat password
Description (optional)	Apartment Verbier
E-mail address (optional)	mike.sample@vodafone.uk
Language	English
User group	Enduser
OK Cancel	

2. Enter / Select user data:
 - User name
 - Password
 - Repeat password
 - Description (optional)
 - E-mail address (optional)
 - Language: English
 - User group
3. Close with [OK]

Change user data

Procedure:

1. Click the red pencil  for the corresponding user
The "Change user" dialog box opens.

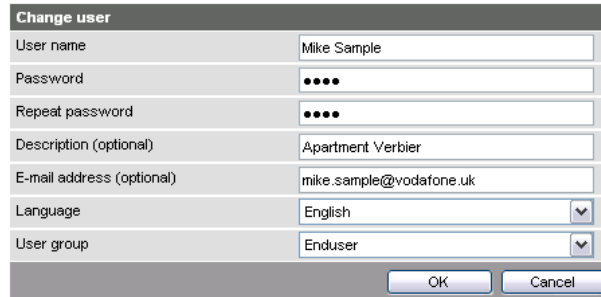

Change user	
User name	Mike Sample
Password	••••
Repeat password	••••
Description (optional)	Apartment Verbier
E-mail address (optional)	mike.sample@vodafone.uk
Language	English
User group	Enduser

2. Change user data:
 - User name
 - Password
 - Repeat password
 - Description (optional)
 - E-mail address (optional)
 - Language: English
 - User group.
3. Close with [OK]

Delete user account

Procedure:

1. Click the red recycle bin  for the corresponding user.
The "User accounts" dialog box opens.



User accounts	
[?] User to be deleted?	Yes No

2. Click [Yes] to confirm "User to be deleted?".

Notes



- The administrator account cannot be deleted. The name "Administrator" and user group "Administrator" cannot be changed. You may, however, add user accounts with administrator rights.
- You can only add new users and delete existing ones on the "Administrator" user level.
- Changing other user accounts is reserved to the "Administrator" user level.
- A secure password is comprised of letters, numbers and special characters, is at least 20 characters in length and does not include a name or words from dictionaries.

2.4 Create device web pages

Create device websites

The associated devices must be recorded and the device websites generated before operating the Web Server and the Synco devices. Use the "Device web pages" menu.

Note

 Device web pages can only be created on the "Administrator" user level.



Device name	Device address	Device type	Serial no	State	Generated on
<input type="checkbox"/> OZW772.250	0.2.150	OZW772.250	00FD00FF0644	Generated	05.03.2012 11:31
<input type="checkbox"/> QAX913	0.2.200	QAX913-DE	00FD000763FE	Generated	07.03.2012 09:44
<input type="checkbox"/> RMH760B-1	0.2.210	RMH760B-1	00FD0007A091	Generated	07.03.2012 09:49
<input type="checkbox"/> RMU730B-1	0.2.220	RMU730B-1	00FD0007980B	Generated	07.03.2012 09:55

Add Delete Generate Hide

Linked devices are listed in a table with the following information:

- Device name
- Device address
- Device type
- Serial number
- State
- Generated on

You can sort the table by clicking 

Notes

- 
- The Web Server itself is already in the device list.
 - Only added devices are monitored.
 - Only generated devices can be operated.
 - Device web pages can only be generated on the "Administrator" user level.
 - Changes to settings of the connected Synco device may require that the device web pages be recreated or updated to apply changes from web operation.
 - You must delete and re-add to replace a Synco device.

Add devices

Procedure:

1. Click [Add]
2. Enter serial number.



Add device

Serial number:

OK Cancel

 The serial number is located on the type label for Synco devices.

3. Confirm with [OK]

The Web Server searches for the device with the corresponding serial number. It appears in the device list if found.

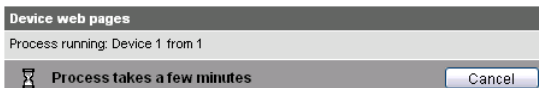

Device web pages

Process running: Device 1 from 1

 Process takes a few minutes

Cancel



Device web pages

 Process finished

OK

- Select devices whose web pages you want to create.

Device name	Device address	Device type	Serial no	State	Generated on
<input type="checkbox"/> OZW772.250	0.2.150	OZW772.250	00FD00FF0644	Generated	05.03.2012 11:31
<input type="checkbox"/> QA×913	0.2.200	QA×913-DE	00FD000763FE	Generated	07.03.2012 09:44
<input type="checkbox"/> RMH760B-1	0.2.210	RMH760B-1	00FD0007A091	Generated	07.03.2012 09:49
<input checked="" type="checkbox"/> RMU730B-1	0.2.220	RMU730B-1	00FD00079808	Generated	07.03.2012 09:55
<input checked="" type="checkbox"/> Device 230	0.2.230	RMU730-1	00FD00001 DF7	Generated	07.03.2012 10:12

- Click [Generate]
Device web pages are generated.
 The process may take a few minutes.

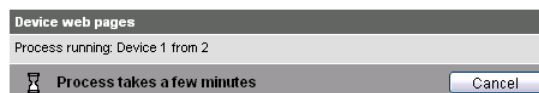

- Wait until the message " Process finished" is displayed.



- Close with [OK]
 The device list for the Web Server and Synco devices displays status "Generated".

Device name	Device address	Device type	Serial no	State	Generated on
<input type="checkbox"/> OZW772.250	0.2.150	OZW772.250	00FD00FF0644	Generated	05.03.2012 11:31
<input type="checkbox"/> QA×913	0.2.200	QA×913-DE	00FD000763FE	Generated	07.03.2012 09:44
<input type="checkbox"/> RMH760B-1	0.2.210	RMH760B-1	00FD0007A091	Generated	07.03.2012 09:49
<input type="checkbox"/> RMU730B-1	0.2.220	RMU730B-1	00FD00079808	Generated	07.03.2012 09:55
<input type="checkbox"/> Device 230	0.2.230	RMU730-1	00FD00001 DF7	Generated	07.03.2012 10:12

Delete device

Procedure:

- Select the Synco device you want to remove from the device list

<input type="checkbox"/> RMU730B-1	0.2.220	RMU730B-1	00FD00079808	Generated	07.03.2012 09:55
<input checked="" type="checkbox"/> Device 230	0.2.230	RMU730-1	00FD00001 DF7	Generated	07.03.2012 10:12

- Click [Delete]
- Confirm with [Yes]

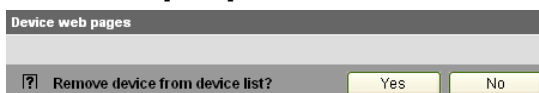

- The Web Server removes the device from the device list.

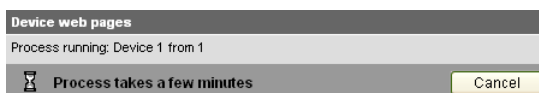

- Wait until the message " Process finished" is displayed.



- Click [OK] to confirm.
The device is deleted from the device list.

Device name	Device address	Device type	Serial no	State	Generated on
<input type="checkbox"/> OZW772.250	0.2.150	OZW772.250	00FD00FF0644	Generated	05.03.2012 11:31
<input type="checkbox"/> QA×913	0.2.200	QA×913-DE	00FD000763FE	Generated	07.03.2012 09:44
<input type="checkbox"/> RMH760B-1	0.2.210	RMH760B-1	00FD0007A091	Generated	07.03.2012 09:49
<input type="checkbox"/> RMU730B-1	0.2.220	RMU730B-1	00FD00079808	Generated	07.03.2012 09:55

Update device web pages

The following changes to user defined texts result in outdated device web pages:

- Menu tree names *, e.g. Message receiver 1...4.
- Web Server plant names.
- Plant names for Synco devices (e.g. QAX913).

The impact and restore differ for the three changes mentioned above based on internal KNX data storage.

Change	Device list (device web pages)		Texts in sec. navigation		Generate/Update	Delete, Add
	Device name	Status	Menus	Device nodes		
Menu tree names *, e.g. Message receiver 1...4	n/a	Outdated	Outdated	n/a	Required	no
Web Server plant name	Current	Generate	Current	Outdated	Required	no
Plant name for Synco device(s)	Outdated	Generate	Current	Outdated **	No	Required

* Menu tree names are user defined texts displayed in secondary navigation (menu tree)

** Even after generate

Notes



- You can update device web pages on user levels "Administrator" and "Service".
- Click "Update" on the service level and "Generate" on the Administrator level to start updating (see "Create device web pages").
- You can only delete a Synco device on the "Administrator" user level.

Tip

When deleting or adding a Synco device (see above for description of workflow), we recommend copying (select and right-click: Copy) the serial number to the clipboard prior to deleting.

2.5 Web Server settings

The "Home" menu is used to set the Web Server. The Web Server and then the corresponding operating page are selected in secondary navigation.

Notes



- The settings depend on the user level.
- Only data points that can be read are described in this section.

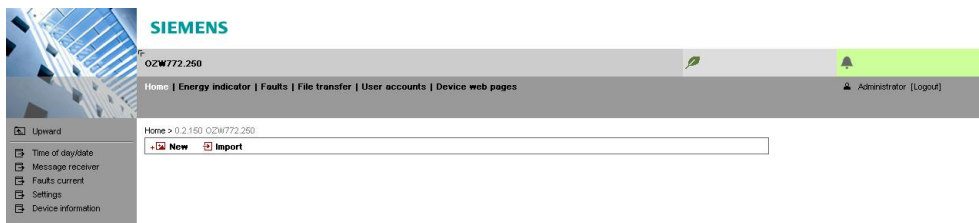

2.5.1 Operating page settings "Time of day/date"

Time of day/date

Time/data can be set during operation.

Path: Home > 0.2.150 OZW772.xx > Time of day/date

Power reserve



The clock has a backup battery for at least 72 hours. The clock continues to run after power failure for the duration of the backup battery.

Both date and time are reset in case of an extended interruption.

- It is corrected automatically if the time is synchronized to the master clock on the KNX bus (see Section 2.5.3.3).
- Otherwise, both date and time must be reset.

Data point	Explanation, example		
Time of day/date Default val: 00:00 1.1.2005 Setting val: Time of day/date	The setting values are derived from the current time clock and the current date. Weekday is calculated automatically.		

Datapoint	Value
Time of day/date	Wednesday, 29. February 2012 12:20

Time of day/date

Time of day

Date

Weekday

2.5.2 Operating page "Faults current"

Local faults and faults in system are displayed under "Faults current".

Path: Home > 0.5 OZW672... > Faults current



A description of faults is available in Section 4.3, "Faults"

2.5.3 Operating page "Settings"

2.5.3.1 Web Server

Language and code number

Path: Home > 0.2.150 OZW772.xx > Settings > Web Server



Data point	Explanation, example		
Language Default val: English Setting val: see example	Web Server language: Is used for Web Server fault texts, message history, messages and system reports.	●	—
Code Default val: 01 Setting val: max. 20 charact.	Access code for PC Software ACS790.	●	—
Reset admin password * Default val: No Setting val: Yes	If you do not know the administrator password for the Web Server, setting value "Yes" again provides access to the Web Server via the administrator password "Password". "Password or Password.1" is possible again (Administrator password for delivery of devices to Version 5.2 = "Password", for devices as of Version 6.0 = "Password.1"). Setting value "Yes" is a temporary state, i.e. the setting value automatically goes to "No" after ca. 2 seconds.	* —	* —

* with PC software ACS790 only.

2.5.3.2 Time of day/date

Time zone



Path: Home > 0.2.150 OZW772.xx > Settings > Time of day/date

Data point	Explanation, example		
Time zone Default val: GMT +01:00 Berlin, Rome Setting val: misc. Time zones	The time zone setting value is based on UTC (GMT). The time zone also defines daylight saving time / standard time changeover.	●	—

2.5.3.3 Communication

KNX

Path: Home > 0.2.150 OZW772.xx > Settings > Communication > KNX

Data point	Explanation, example		
Range	Displays the range within the KNX bus. e.g. 0 for address 0.2.150 The range is set in ETS.	—	—
Line	Display of line within the KNX bus. e.g. 2 for address 0.2.150 The line is set in ETS.	—	—
Device address Default val: 150 Setting val: 1... 253	Set device address. The device address must be unique within the same KNX line.	●	—
Time synchronization Default value: Slave on bus Setting values: Slave on Bus Quartz	Defines time synchronization on the Web Server. Default value "Slave on bus": Clock master is available on the KNX network. Setting value "Quartz": The clock is synchronized with quartz on the Web Server. Web Server operates a clock master or autonomously.	●	—
Clock time mode KNX Default val: Autonomous Setting val: Autonomous/Master	"Slave" for "Time synchronization" = "Slave on bus". For "Time synchronization" = "Quartz", can selected between "Autonomous" or "Master".	●	—
Clock slave remote adj KNX Default val: Yes Setting val: Yes / No	Setting value is important for "Time synchronization" = "Slave on bus". For "Clock slave remote adj KNX" = "Yes" the time clock for the clock master on the KNX network can be changed via the time clock for the Web Server.	●	—

The following data points are information parameters. They are described in Section 4.2.3, "Web Server diagnostics":

- Maximum number of devices
- Current number of devices
- Last change

Ethernet

Path: Home > 0.2.150 OZW772.xx > Settings > Communication > Ethernet

Notes



- Enter these settings if you intend to operate the Web Server on a local area network (LAN) or via the Internet.
- Alternative settings are available for operating with DHCP client switched off.
- Entries for the various network topologies are described in Section 8.1.

Data point	Explanation, example		
DHCP client Default val: On Setting val: Off, On	Service automatically getting the Web-Server's IP network configuration automatically from the router; see Section 8.1.2.	<input checked="" type="radio"/>	<input type="radio"/>
IP address Default val: 192.168.2.10 Setting val: IP address	Web Server IP address. Does not require setting if "DHCP client = On".	<input checked="" type="radio"/>	<input type="radio"/>
Subnet mask Default val: 255.255.255.0 Setting val: IP address	The IP subnet mask sets the size of the subnet. Does not require setting if "DHCP client = On".	<input checked="" type="radio"/>	<input type="radio"/>
Default gateway Default val: 192.168.2.1 Setting val: IP address	The standard gateway represents the interface between the local and public network. You typically enter the IP address for the router here. Does not require setting if "DHCP client = On".	<input checked="" type="radio"/>	<input type="radio"/>
Preferred DNS server Default val: 192.168.2.1 Setting val: IP address	The DNS server (domain name system) on the Internet connects a globally valid name to a domain with an IP address (e.g. domain www.siemens.com with IP address 146.254.191.150). The setting corresponds to the IP address for the next router or DNS server that recognizes for its part a queried name (domain) or another DNS server. The setting is typically identical to the setting for the standard Gateway. Required to send e-mails. Does not require setting if "DHCP client = On".	<input checked="" type="radio"/>	<input type="radio"/>
Alternate DNS server Default val: (blank) Setting val: IP address	The alternative DNS server is only defined for redundant systems. Settings are typically empty. Does not require setting if "DHCP client = On".	<input checked="" type="radio"/>	<input type="radio"/>
UPnP localization Default val: Ethernet Setting val: ---, Ethernet, USB	The Web Server registers its presence in the network via the Universal Plug and Play (UPnP) service.	<input checked="" type="radio"/>	<input type="radio"/>

The data point "Physical address" is an information parameter. It is described in Section 4.3, "Faults".

If the DHCP client is switched off, the corresponding settings must be entered manually.



Set when DHCP client off

IP address	192.168.2.10	
Subnet mask	255.255.255.0	
Default gateway	192.168.2.1	
Preferred DNS server	192.168.2.1	
Alternate DNS server		

E-mail



Path: Home > 0.2.150 OZW772.xx > Settings > Communication > E-mail

-  • Enter these settings if the Web Server sends e-mails (report faults / send consumption file).
- Additional information on e-mail settings is available in Section 8.2.
- Automatically negotiate the securest connection:
 TLS mode is selected automatically if the device sending the email and the email provider support TLS.

Data point	Explanation, example		
Address mail server Default val: smtp.example.com Setting val: max. 49 characters	Contact the Internet service provider for the mail server's address (IP address) or name (domain). Often referred to as the outgoing mail server or SMTP server instead of mail server.	●	—
Port number mail server Default val: 25 Setting val: 1...65535	Port number 25 is default for the mail server (and does not normally require change).	●	—
E-mail address sender Default val: ozw772@example.com Setting val: max. 49 characters	The setting corresponds to the e-mail address of the Web Server. The e-mail address is displayed in the "From" field of each e-mail.	●	—
Authentication mail server Default val: No Setting val: No/Yes	Select Yes for mail server access with authentication. In this case, user name and password (see next two data points below) are required.	●	—
User name Default val: (blank) Setting val: max. 49 characters	User name and password help authenticate each e-mail via the mail server.	●	—
Password Default val: (blank) Setting val: max. 49 characters	Password and user name help authenticate each e-mail via the mail server.	●	—
Signature line 1...10 Default val: (blank) Setting val: max. 49 characters	Signature lines are transmitted with the e-mail. It identifies the sender, e.g. the plant's Internet address.	●	—



USB

Path: Home > 0.2.150 OZW772.xx > Settings > Communication > USB

Data point	Explanation, example		
UPnP localization Default val: USB Setting val: ---, Ethernet, USB	The Web Server registers its presence in the network via the Universal Plug and Play (UPnP) service.	●	—

UPnP localization

-  Web Server registers its existence in the USB network, when
 - "UPnP localization = USB" is set *and*
 - The connection between PC/laptop and the Web Server is active via USB.

Data point	Explanation, example		
ACS access Default value: On Setting values: On/Off	Permits access by ACS operating software to the Web Server (only possible via direct connection – not possible via the portal). For security reasons, ACS access should be switched off after commissioning.	<input checked="" type="radio"/>	<input type="radio"/>
Web access via http Default value: Off Setting values: On/Off	Permits communication using the http protocol rather than the secured https connection. Siemens recommends https. The user is responsible for using http.	<input checked="" type="radio"/>	<input type="radio"/>
UPnP localization Default value: Ethernet Setting value: ---, Ethernet, USB	The Web-Server registers its existence in the corresponding network using the Universal Plug and Play (UPnP) service.	<input checked="" type="radio"/>	<input type="radio"/>
ETS access via KNXnet/IP Default value: On Setting values: On/Off	Permits access to the plant using ETS software via KNXnet/IP (using direct connection only – not possible via portal)	<input checked="" type="radio"/>	<input type="radio"/>
Portal connection Default value: On Setting values: On/Off	"On" enables data exchange with the portal. No data is exchanged under "Off".	<input checked="" type="radio"/>	<input type="radio"/>
Automatic log off Default value: On Setting values: On/Off	The connection to Web Server automatically times out after 24 hours.	<input checked="" type="radio"/>	<input type="radio"/>

2.5.3.4 Message receivers

Data points are available for function checks of message receivers. They are available under the following path:

Path: Home > 0.5 OZW772... > Settings > Message receivers



The use of these data points (test message receivers, send system report, reason, message suppression) is described in Section 2.7, Functional check.

Message receivers 1...4

Message receivers must be defined if the Web Server sends fault messages via email.

Settings can be made separately for 4 message receiver:

Path: Home > 0.2.150 OZW772.xx > Settings > Message receiver >

Data point	Explanation, example		
Message receiver 1...4 Def value: (message receiver x) Setting values: max. 20 characters	Message receiver 1...4 is a name (text) and is displayed in the web browser. You must run "generate" to display the change (for the workflow, see Section "Refresh device web pages" in Section 2.4).	●	—
Receiver type Default value: --- Setting values: --, E-mail	All Receiver types are available: "---": No messages to this message receiver. "E-mail": Configure message receiver for e-mail.	●	—
Fault priority Default value: All Setting values: All, Only urgent ones	The setting value "Only urgent ones" acts as a filter for sending fault messages.	●	—
Email address Default value: message receiver @example.com Setting values: max. 49 characters	The setting value must match the e-mail address of the message receiver.	●	—
Number of messages for send	Number of messages to be transmitted at next send.	—	—

The number of messages pending is available under "Number of messages for sending".

Send messages

A time frame can be defined during which messages can be sent for each receiver.

Notes





- The following settings are optional when restricting the time for sending messages (default settings: No restriction).
- In general: Messages occurring outside the send periods are sent afterwards if still pending during the send period.

Path: Home > 0.2.150 OZW772.xx > Message receiver > Message receiver 1...4 > Send messages

You can define time periods per weekday or special day when messages can be sent to the message receivers.

Special days are defined via **Holidays/special days**.

Data point	Explanation, example		
Monday...Sunday, Special day Default val: Monday, 00:00 On ... Special day, 00:00 On ... Setting val: Monday - Sunday, Special day 00:00 - 24:00 Off/on	Each message receiver is assigned a time switch to program max. 3 transmission times for each weekday, i.e. periods during which the Web Server can send messages. The default value sends messages throughout the entire period.	●	●

Monday	Tuesday	Wednesday
<input checked="" type="checkbox"/> 00:00 On	<input checked="" type="checkbox"/> 00:00 On	<input checked="" type="checkbox"/> 00:00 On
<input checked="" type="checkbox"/> 02:00 Off	<input checked="" type="checkbox"/> 02:00 Off	<input checked="" type="checkbox"/> 02:00 Off
<input checked="" type="checkbox"/> 04:00 On	<input checked="" type="checkbox"/> 04:00 On	<input checked="" type="checkbox"/> 04:00 On
<input checked="" type="checkbox"/> 06:00 Off	<input checked="" type="checkbox"/> 06:00 Off	<input checked="" type="checkbox"/> 06:00 Off
<input checked="" type="checkbox"/> 08:00 On	<input checked="" type="checkbox"/> 08:00 On	<input checked="" type="checkbox"/> 08:00 On
<input checked="" type="checkbox"/> 10:00 Off	<input checked="" type="checkbox"/> 10:00 Off	<input checked="" type="checkbox"/> 10:00 Off

Thursday	Friday	Saturday
<input checked="" type="checkbox"/> 00:00 On	<input checked="" type="checkbox"/> 00:00 On	<input checked="" type="checkbox"/> 00:00 On
<input checked="" type="checkbox"/> 02:00 Off	<input checked="" type="checkbox"/> 02:00 Off	<input checked="" type="checkbox"/> 02:00 Off
<input checked="" type="checkbox"/> 04:00 On	<input checked="" type="checkbox"/> 04:00 On	<input checked="" type="checkbox"/> 04:00 On
<input checked="" type="checkbox"/> 06:00 Off	<input checked="" type="checkbox"/> 06:00 Off	<input checked="" type="checkbox"/> 06:00 Off
<input checked="" type="checkbox"/> 08:00 On	<input checked="" type="checkbox"/> 08:00 On	<input checked="" type="checkbox"/> 08:00 On
<input checked="" type="checkbox"/> 10:00 Off	<input checked="" type="checkbox"/> 10:00 Off	<input checked="" type="checkbox"/> 10:00 Off

Sunday	Special day	Copy
<input checked="" type="checkbox"/> 00:00 On	<input checked="" type="checkbox"/> 00:00 On	From: Monday
<input checked="" type="checkbox"/> 02:00 Off	<input type="checkbox"/> 00:00 Off	To: <input type="checkbox"/> Monday <input type="checkbox"/> Tuesday
<input checked="" type="checkbox"/> 04:00 On	<input type="checkbox"/> 00:00 Off	<input type="checkbox"/> Wednesday <input type="checkbox"/> Thursday
<input checked="" type="checkbox"/> 06:00 Off	<input type="checkbox"/> 00:00 Off	<input type="checkbox"/> Friday <input type="checkbox"/> Saturday
<input checked="" type="checkbox"/> 08:00 On	<input type="checkbox"/> 00:00 Off	<input type="checkbox"/> Sunday <input type="checkbox"/> Special day
<input checked="" type="checkbox"/> 10:00 Off	<input type="checkbox"/> 00:00 Off	<input type="button" value="Copy"/>

Notes

- Check to enable switching points.
- You can copy the switching times for a day of the week by clicking [Copy] from one day to a selection of other days
- Click [Check] to sort and check the data before saving.

Holidays/special days

Path: Home > 0.2.150 OZW772.xx > Settings > Message receiver > Message receiver 1...4

> Holidays/special days

No messages are sent during vacation/holidays. For special days, sending periods are defined via "Send messages".

Notes

- General: Messages outside sending periods are resent during the next send period.
- If a special day occurs during a holiday/vacation, the day is a special day.
- Holidays/special days can be set as recurring days each year.

Data point	Explanation, example		
Entry 1...16 Default val: --- Setting val: Beginning End Reason Annually	Each receiver is assigned a yearly calendar to enter holidays and special days. Holiday or special day can be selected as Event . Data and time can be used to indicated beginning and end of period. Select "Annually" to repeat the periods each year.	<input checked="" type="checkbox"/>	<input checked="" type="checkbox"/>

	Beginning	End	Reason	Annually
1	<input checked="" type="checkbox"/> 14.07.09 00:00	<input checked="" type="checkbox"/> 29.07.09 23:59	Holidays	<input type="checkbox"/>
2	<input checked="" type="checkbox"/> 24.12.** 00:00	<input checked="" type="checkbox"/> 02.01.** 23:59	Holidays	<input checked="" type="checkbox"/>
3	<input checked="" type="checkbox"/> 01.08.** 00:00	<input checked="" type="checkbox"/> 01.08.** 23:59	Special day	<input checked="" type="checkbox"/>
4	<input type="checkbox"/> 01.01.00 00:00	<input checked="" type="checkbox"/> 01.01.00 23:59	Holidays	<input type="checkbox"/>
5	<input type="checkbox"/> 01.01.00 00:00	<input checked="" type="checkbox"/> 01.01.00 23:59	Holidays	<input type="checkbox"/>
6	<input type="checkbox"/> 01.01.00 00:00	<input checked="" type="checkbox"/> 01.01.00 23:59	Holidays	<input type="checkbox"/>
7	<input type="checkbox"/> 01.01.00 00:00	<input checked="" type="checkbox"/> 01.01.00 23:59	Holidays	<input type="checkbox"/>
8	<input type="checkbox"/> 01.01.00 00:00	<input checked="" type="checkbox"/> 01.01.00 23:59	Holidays	<input type="checkbox"/>
9	<input type="checkbox"/> 01.01.00 00:00	<input checked="" type="checkbox"/> 01.01.00 23:59	Holidays	<input type="checkbox"/>
10	<input type="checkbox"/> 01.01.00 00:00	<input checked="" type="checkbox"/> 01.01.00 23:59	Holidays	<input type="checkbox"/>
11	<input type="checkbox"/> 01.01.00 00:00	<input checked="" type="checkbox"/> 01.01.00 23:59	Holidays	<input type="checkbox"/>
12	<input type="checkbox"/> 01.01.00 00:00	<input checked="" type="checkbox"/> 01.01.00 23:59	Holidays	<input type="checkbox"/>
13	<input type="checkbox"/> 01.01.00 00:00	<input checked="" type="checkbox"/> 01.01.00 23:59	Holidays	<input type="checkbox"/>
14	<input type="checkbox"/> 01.01.00 00:00	<input checked="" type="checkbox"/> 01.01.00 23:59	Holidays	<input type="checkbox"/>
15	<input type="checkbox"/> 01.01.00 00:00	<input checked="" type="checkbox"/> 01.01.00 23:59	Holidays	<input type="checkbox"/>
16	<input type="checkbox"/> 01.01.00 00:00	<input checked="" type="checkbox"/> 01.01.00 23:59	Holidays	<input type="checkbox"/>

Notes



-  • Check to select active entries.
- Select "Annually" to set repetitive switching points.
- Click [Check] to sort and check the data before saving.

2.5.3.5 System report

Path: Home > 0.2.150 OZW772.xx > Settings > System report

Note

-  Enter these settings if the Web Server is to regularly send an e-mail for a fault.

Data point	Explanation, example		
Signal time Default val: 06:00 hh:mm Setting val: 00:00...23:59	The setting value corresponds to the time of day when a system report is sent (once every 24 hours).	●	—
Message cycle Default val: 1 d (day) Setting val: 0...255 d	The setting value corresponds to the interval (in days) at which a system report is sent. The first system report is delivered after completion of the first message cycle and then as per the message cycle. The system report is disabled when the message cycle = 0.	●	—
Priority Default val: Urgent Setting val: Urgent / Not urgent	Filter for sending the system report. Under the setting urgent , the system report is sent to all message receivers. Under the setting not urgent , the message receives are excluded who have only subscribed to "Urgent only" messages.	●	—
Next report Default val: 0 d (day) Setting val: 0...255 d	Waiting period until the next system report is sent.	●	—

2.5.3.6 Consumption data

Web Server provides consumption data functionality in the form of consumption data files. See Section 6 for additional information.

Plant information

Path: Home > 0.2.150 OZW772.xx > Settings > Consumption data > Plant information

Note





The settings set user defined data fields, section display and one centralized due date for the consumption data file.

Data point	Explanation, example		
Plant name Default val: (blank) Setting val: max. 20 characters	Web Server or plant name.	<input checked="" type="radio"/>	<input type="radio"/>
Header Default val: (blank) Setting val: max. 49 characters	Header for consumption data file.	<input checked="" type="radio"/>	<input type="radio"/>
Information line 1...10 Default val: (blank) Setting val: max. 49 characters	The information lines are saved to the consumption file. They are freely applicable, e.g. to identify the send by post or internet address for the plant.	<input checked="" type="radio"/>	<input type="radio"/>
Footer Default val: (blank) Setting val: max. 49 characters	Footer consumption data file.	<input checked="" type="radio"/>	<input type="radio"/>
Delete meter replacement section Default val: No Setting val: No, Yes	Delete meter replacement section for consumption data file.	<input checked="" type="radio"/>	<input type="radio"/>
Due day date Default val: 31. December setting val: Jan 1...Dec. 31.	Centralized due day applicable to all WRI982 pulse inputs and for all M-bus meters. A due day on the M-bus meter that differs from this due day is ignored. The last or first day of the month is typically entered. The due day value is only transmitted on the third day of the month to the Web Server.	<input checked="" type="radio"/>	<input type="radio"/>
Send due day date Default val: Off Setting val: Off, On	Enable send of centralized due day.	<input checked="" type="radio"/>	<input type="radio"/>

Receiver Path: Home > 0.2.150 OZW772.xx > Settings > Consumption data > Receiver > E-mail receiver 1...2

- Notes  • The settings configure sending the consumption data file per e-mail.
 • The e-mail signature (sender name, address, etc.) is set under "Settings > Communication > E-mail".
 • The settings are independent of the settings for the message receiver (Section Message receiver 1...4).

Data point	Explanation, example		
E-mail address Default val: mailReceiver@example.com Setting val: max. 49 characters	The setting must match the consumption data receiver's e-mail address.	<input checked="" type="radio"/>	<input type="checkbox"/>
Transmit interval Default val: Never Setting val: Never, daily, weekly, monthly	The send interval sets how often consumption data is sent to the e-mail receiver. The setting "Never" corresponds to "turned off".	<input checked="" type="radio"/>	<input type="checkbox"/>
File format Default val: .xml Setting val: (empty), .xml, .csv	The file format sets the format of the e-mail attached for consumption data. Two files are attached if both formats are selected. No file is added is the setting is empty.	<input checked="" type="radio"/>	<input type="checkbox"/>
Test receiver Default val: --- Setting val: ---, Trigger	"Test receiver" tests the connected to the selected receiver.	<input checked="" type="radio"/>	<input type="checkbox"/>

- Notes  On send interval:
- It is generally sent as soon as the data collection is completed for the Web Server.
 - Daily means between 5 and 10 am.
 - Weekly means Sundays (between 5 and 10 am).
 - Monthly refers to the third day of the month (between 5 am and 10 pm).

In the case of "Annual allocation", "monthly" can be selected: The 11 additional e-mails with attached consumption data files are available for backup purposes or to provide precise billing by the month in the event of a change of renters.

2.5.3.7 Energy indicator

The menu "Energy indicator" is displayed if the controller is connected to the Web Server that supports the Energy indicator. The menu is hidden if no devices of this type are connected.

E-Mail receiver 1...2 2 e-mail receivers can be defined for the Energy indicator. Settings are made at:

Path: Home > 0.2.150 OZW772.xx > > Settings > Energy indicator

The descriptions are available in Section 7.5 "E-mail with "Energy indicator" for the plant".

Visibility Visibility of the "Energy indicator" can be defined:

Path: Home > 0.2.150 OZW772.xx > Settings > Energy indicator

The descriptions are available in Section 7.2.5 "Energy indicator" visibility".

2.5.3.8 Trend

2 e-mail receivers can be defined for the trend function. Each of the 4 trend channels can send its information at the defined interval to one or both e-mail receivers. The settings is at:

Path: Home > 0.2.150 OZW772.xx > Settings > Trend

A description is available in Section 9.3, "Send trend data by e-mail".

2.5.3.9 Faults

Enter these settings if the Web Server is to send an e-mail for a fault.

Path: Home > 0.2.150 OZW772.xx > Settings > Faults

General functions

Data point	Explanation, example		
Delete history Default value: No Setting values: No, Yes	Deletes the history of all events and messages. Note : Setting value Yes is a temporary state, after approximately 2 seconds, the setting value returns automatically to No .	<input checked="" type="radio"/>	—

Local

Data point	Explanation, example		
Message triggering Default val.: Coming Setting val: Coming, Coming and going	Coming: A message is triggered when a fault is received (start of fault). Coming and going: A corresponding message is triggered at start and end of fault. A Web Server fault displays the LED .	<input checked="" type="radio"/>	—

Note

"Local" faults refer to Web Server faults.

Data point	Explanation, example		
Message triggering Default val: Coming Setting val: Coming, Coming and going	Coming: a message is triggered when a fault is received (start of fault). Coming and going: A corresponding message is triggered at start and end of fault. A Web Server fault displays the LED .	<input checked="" type="radio"/>	—

System

Data point	Explanation, example		
Message triggering Default val.: Coming Setting val: Coming, Coming and going	Coming: A message is triggered when a fault is received (start of fault). Coming and going: A corresponding message is triggered at start and end of fault. This "Message triggering" impacts faults for devices on the KNX network (System) that are included on the Web Server device list. A fault to Synco devices is displayed with the LED .	<input checked="" type="radio"/>	—

Note

"System" faults refer to faults to the KNX device received via the KNX bus.

2.5.3.10 Texts

Path: Home > 0.2.150 OZW772.xx > Settings > Texts

Data point	Explanation, example		
Plant name Default val: OZW772.01 OZW772.04 OZW772.16 OZW772.250 Setting val: max. 20 characters	User definable text for the plant displayed by Web Server and transmitted in the message. You must run "Generate" to display the change (on the workflow, see Section "Refresh device web pages" in Section 2.4).	<input checked="" type="checkbox"/>	<input type="checkbox"/>

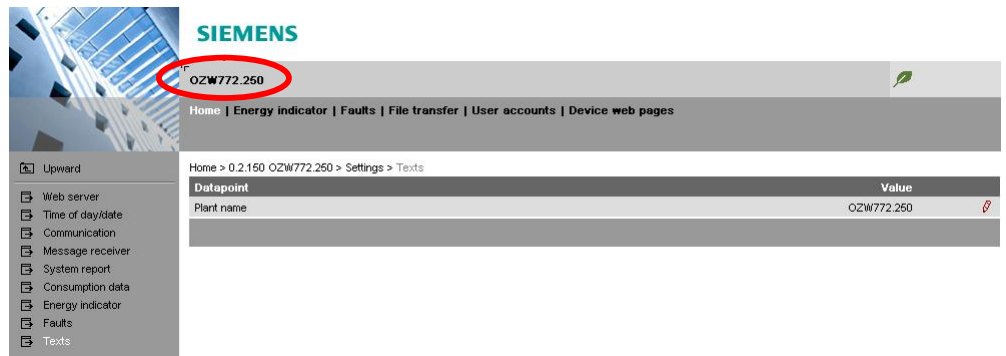

2.5.4 Operating page "Device information"

The operating page "Device information" displays information on Web Server, LPB/BSB, Ethernet, and services.

Path: Home > 0.2.150 OZW772.xx > > Device information

Descriptions are available in Section 4.2.3 "Web Server diagnostics".

2.6 Commission network components

Commissioning

The Web Server can be operated from a PC with web browser on a local area network (LAN) or via the Internet.

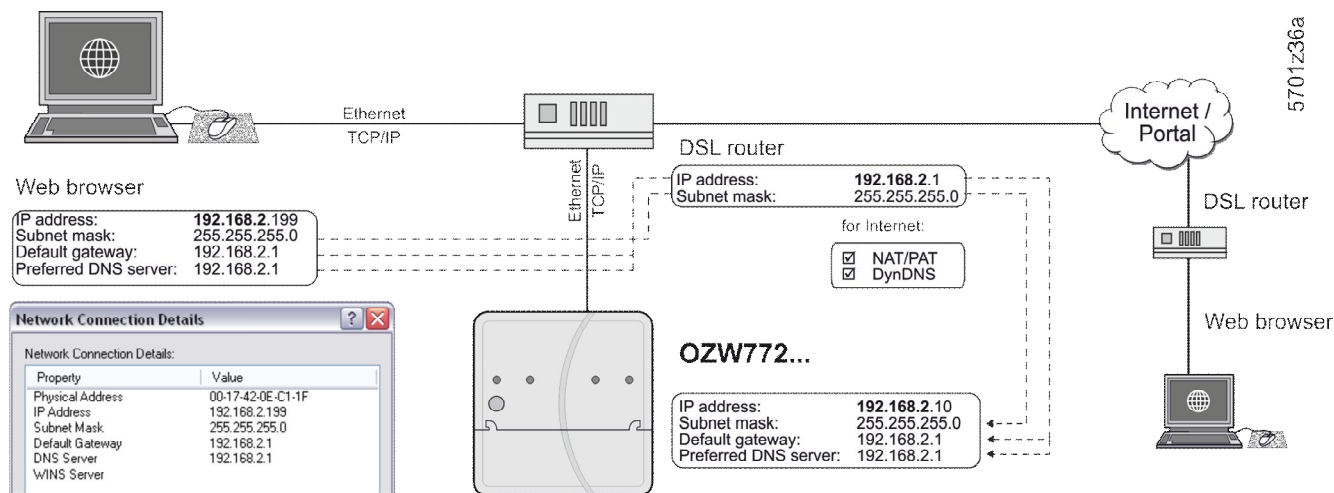

The illustration shows a typical application with operation via Internet and home network. Use can use "Network connection" to issue IP address, subnet mask, standard gateway and preferred DNS server if the PC is connected to the home network.

2.6.1 Access via portal

OZW registers automatically on the portal during commissioning as soon as it is connected to the Internet.

All functions are available after the user also logs on to the portal and the plant is activated. No additional settings required on the router. The workflow for access via portal is described in Section 3.1 "Set up access via portal".

2.6.2 Access via a local area network (LAN)

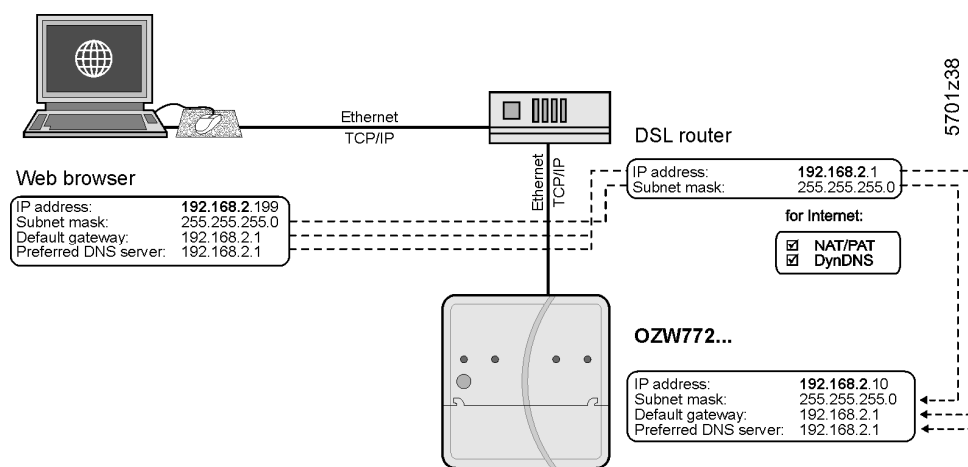

Operator station

The operator station requires these settings, if the Web Server is operated from a PC with web browser on a local area network (LAN):

- IP address
- Subnet mask

Note



Settings depend on network type and application. The different variants are described in Section 8.1.2.

2.6.3 Access via direct connection

"Direct connection" access the plant via the Internet by querying a fixed IP address for the Web Server or by querying a dynamic IP address forwarded via a server.

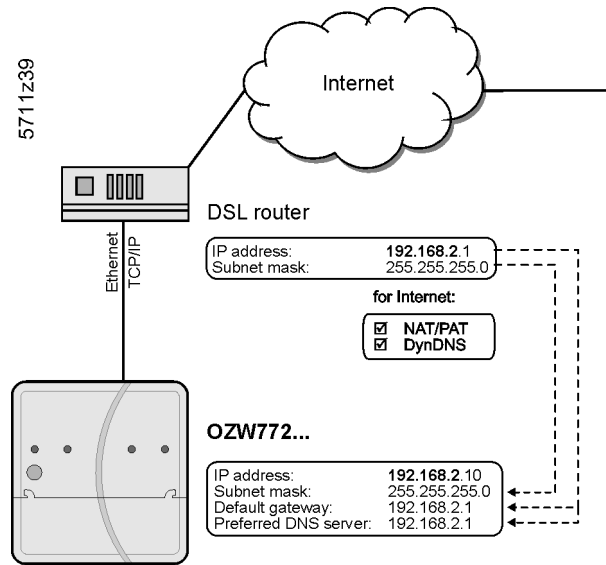

Router

Remote access (e.g. DSL router with Internet connection) is already set up. The firewall must permit plant access to the Internet.

OZW uses the following fixed ports:

- http (recommended only on private network) 80
- https (recommended on public network) 443
- ACS Tool 50005
- ACS Offline Trend and FTP 21

Note



Port 80 is disabled by default. Access via http (Port 80) is unsecure. The user is responsible for enabling port 80.

Always selected an https connection (Port 443 is enabled by default).

The router settings below are required, when

- Accessing the Web Server from outside the local area network without using the portal.
- A message is send via email for a fault.

A static IP address or Dynamic DNS-capable router with Dynamic DNS service is prerequisite for operation via Internet.

Settings:



- NAT/PAT: Translate public to private IP addresses and ports
- Dynamic DNS: The dynamic IP address for the connection must be published if no fixed public IP address is available.

Settings depend on network type and application. The different variants are described in Section 8.1.3, "Access via direct connection".

2.7 Functional check

Test condition	Connections must be tested if all settings were made to the Web Server as well as to KNX devices.
LAN	A PC on the local network is used to test operations via LAN. The log in dialog box must appear after entering the local IP address for the Web Server (see Section 2.2.2).
Internet	We recommend using mobile participants with Internet access (Smart phone, mobile phone) to test operation over the Internet. The log in dialog box must appear after entering the public IP address or plant domain.
Access via portal	Access via portal must be possible after registration, log on, and plant activations (see Section 3.1 "Set up access via portal").
Access without portal	The log in dialog box displays after entering the public IP address of plant domain (see Section 4 "Operate using a web browser").
Test message receiver	Do the test if the Web Server is to send a message or system report via e-mail for a fault.
Note	 <ul style="list-style-type: none"> The test is also carried out if message inhibition is switched on.

Path: Home > 0.2.150 OZW772.xx > Settings > Message receiver

Data point	Explanation, example		
Test message receiver Default val: --- Setting val: Message receiver 1..4	Select a message receiver to test the connection to the receiver.	<input checked="" type="radio"/>	—
System report sent Display val: ---, Yes, No	The display changes from "---" after a few seconds to: "Yes": Message sent successfully "No": Message receiver not reached	<input type="radio"/>	—
Cause Display val: ---, Network cable, DNS setting, Address mail server, Port number mail server, E-mail address receiver, Authentication mail server See the following table.	"Cause" displays the results of "System report sent". For "Yes" the cause is "---". For "No" the cause is displayed. The first cause is displayed for multiple faults.	<input type="radio"/>	—
Message inhibition Display values: Yes, No	Shows the message suppression switch setting (8) (see Section 1.2).	<input type="radio"/>	—

Fault message,
E-mail

A fault message is sent to the appropriate message receiver and the reason displayed if an e-mail cannot be sent error-free to a message receive.

A specific cause can originate in different sources. The problem must be solved accordingly.

Cause	Cause of error	Solution
---	No error	---
Network cable	No network cable or no active network connected.	Connect cable or active network. LEDs must be lit at Ethernet connection.
DNS setting	DNS server could not be reached or no guaranteed network connection.	Check Setting DNS server, Default gateway, or network connection.
Address mail server	Address mail server not discovered by DNS server.	Check Address mail server, Default gateway, or network connection.
Port number mail server	Mail server refuses connection or does not answer.	Check Port number mail server. A company proxy server may block Internet connection.
E-mail address receiver	Invalid E-mail address.	Check E-mail address.
Authentication mail server	Mail server refuses connection. Inconsistent Mail server response. "Authentication mail server" contains different errors. Encrypted mail server (i.e. with TLS = Transport Layer Security) may not be supported.	Check "Authentication mail server = Yes" and user name and Password. An invalid "E-mail address sender" can also result in this error.

Reset fault messages

The fault message is reset if:

- The next e-mail is error free.
- A manually triggered "Test message receiver" is successful.
- The message receiver is deactivated.

Test e-mail receiver consumption data

Path: Home > 0.2.150 OZW772.xx > Settings > Consumption data > Receiver

Note



Do the test if the Web Server sends consumption data via e-mail.

Data point	Explanation, example		
Test receiver Default val: --- Setting val: ---, Trigger	"Test receiver" tests the connected to the selected receiver.	<input checked="" type="radio"/>	—
Consumption data sent Display val: ---, Yes, No	The display changes after a few seconds from "—" to Yes: Message sent successfully. No: Message receiver not reached.	<input type="radio"/>	—
Cause Display val: ---, Network cable, DNS setting, Address mail server, Port number mail server, E-mail address receiver, Authentication mail server.	"Cause" displays the results of "Test receiver". For "Yes" the cause is "—" For "No" the cause is displayed. The first fault is displayed for multiple faults.	<input type="radio"/>	—

2.8 Additional settings

Hide devices

You can determine whether a device in the device list can be operated under "Home".

Note



You can only hide devices on the "Administrator" user level.

Procedure:

1. Select "Device web pages"
2. Select the device you want to hide.
3. Click [Hide]

Device name	Device address	Device type	Serial no	State	Generated on
<input checked="" type="checkbox"/> OZW772.01	0.2.150	OZW772.01	00FD00FF020D	Generated	23.11.2009 09:44
<input type="checkbox"/> Device	0.2.246	RMU710B-1	00FD0001E8A4	Generated	25.11.2009 16:51

Add Delete Generate Hide

Note



Click [Generate] again to show the device. This may have an impact on the display of any existing meters in the consumption data file (For details see Section 6.2, Sections replace meter and section Start value Web Server).

Delete history

Path: Home > 0.2.150 OZW772.xx > Settings > Faults

Note



We recommend deleting the history after you have completed commissioning. The workflow is described in Section 2.5.3.9, "Faults".

2.9 Final steps

2.9.1 Check faults

Fault indication

The fault indicator displays the plant state.

Notes



No faults may be pending after commissioning. Additional information on faults is available in Section 4.3.

No fault

The fault indicator remains green as long as no fault is pending.

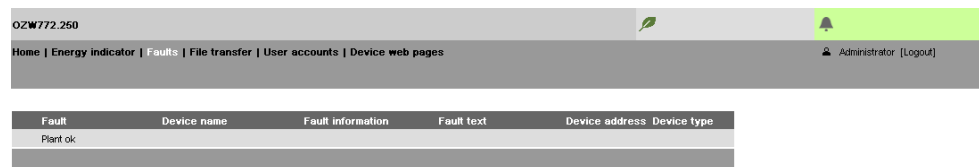

Fault

The fault indicator changes to red for faults. The most severe plant faults are displayed.

- Device name
- Fault text

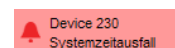

2.9.2 Final steps on Web Server

Final steps

The final function checks are conducted on the Web Server, the cover is mounted and the LEDs checked.

Note



On display and operating elements, see Section 1.2.

Procedure:

1. Unplug USB cable.
2. Switch off message inhibition and address mode.
 - Switch 8 must be set to "Off"
 - Address mode LED must be off.
3. Mount terminal cover.
4. Press Remote button for more than 6 seconds.
 - The Web Server sends a system report to the defined message receivers.
 - Fault LED displays (flashing) error in establishing communications.
5. LED On must be steady green.
6. Fault LED must be off.

2.10 Supply state

Restore default state

The Web Server can be reset to factory default settings. This is probably a good idea when using the Web Server for another plant.

Procedure:

1. Simultaneously press "Long" (> 6 seconds) on the "Remote" ✓ button and "Prog" Prog. The LED "On" ① turns off. The Web Server restarts.
2. Wait until the Web Server is operational (LED "Run" ① is green).

Note



When restoring default state:

- All settings are reset to default state.
- Plant diagrams are deleted.
- The device list is deleted.
- Uploaded files are deleted.
- Unsent messages are deleted.
- History data is **not** deleted:
It must be deleted manually (see Section 2.8).

Note



The KNX device addresses and Ethernet IP address are also reset to default state.

2.11 Software updates

We differentiate between the following:

- System definition updates to integrate device descriptions of new devices in the Web Server.
- Firmware updates to update the Web Server to the latest firmware version. Firmware updates may also contain new device descriptions (system definitions).

System data update

The Web Server supports a number of Synco devices and differentiates them via device descriptions. A text catalog with various languages contains all Web Server texts and device descriptions.

Note



A system definition update is a simply operational step via web browser. See Section 4.4 for information on uploading system definitions.

The current, installed version of system definitions is displayed in device info.

Firmware update

Local operation on Web Server required to update firmware. Procedures are communicated for any firmware update accordingly.

Logo update

The logos can be customized.

3 Remote access via portal

Siemens offers with the Synco IC Internet portal simple and secure access to web servers (available as of Web Server version 5.2).

It permits remote servicing of the plant at any time and from any location.

The user logs on via an html5 compatible web browser (e.g. IE10+, FF18+) on the portal and has access there to all portal settings and plant data for the user level and plant role.

This section describes how to set up access to the Web Server via Synco IC Internet portal.

Benefits to using the portal

- Simple and fast set up of access via the Internet – neither a fixed IP address, nor forwarding of a dynamic IP address, nor port forwarding (NAT/PAT) is required
- The portal provides additional functions:
 - Manage one or multiple plants
 - Central user management
 - Display of plant overview, state of Energy indicators, and alarms
 - Plant functional scope can be set for various plant roles
 - Logging fault messages as common faults
 - Send alarm notifications per e-mail
 - Secured communications through encryption (https)

Web Server on corporate networks

The Web Server does not permit settings on any existing proxy servers and cannot forward any of these settings. Web Servers on corporate networks with proxy servers cannot connect to the portal.

Portal functions

In this section describes only portal functions required to set up access and for understanding interactions.

A detailed description of the portal functions is available on the portal's help number. The documentation button opens the documentation menu.

3.1 Set up access via portal

Setting up the portal connection is easier and faster than setting up a direct connection using a fixed or dynamic IP address.

The Web Server send its device ID and activation key automatically via a secured connection to the portal as soon as it is connected to the Internet.

The user must register on the portal, log in, and activate the plant to access the plant.

Data exchange

Plant data is only exchanged between the Web Server and the portal if the user requests the data.

The sole exception is periodic log in by the Web Server on the portal. This exchange is required to ensure the user can access the plant at any time.

Data access

Only users with the appropriate access rights have access to the data (see Section 3.1.1, "Portal and plant roles".)

For a customer (typically OEM customers), another domain name can be used to set up a different portal appearance.

Query portal

The portal can be queried via the following domains:

<https://www.siemens-syncoic.com>

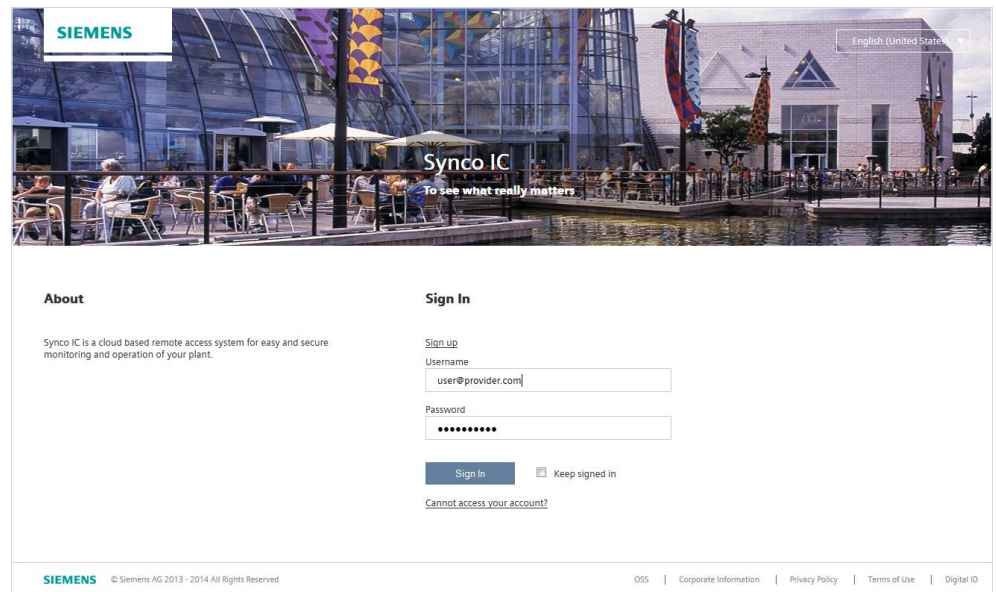

Operating language

The button in the upper right corner selects the portal operating language.



Registration

Registration is required the first time the portal is used. Enter an e-mail address and activation key to register. The activation key is provided with the device as a package insert.

Sign up - Create a new account

Email

New Activation Key

A password needs to be entered for future access to the portal. Additional information can be added for users and plants.

Without package insert

If the activation key, supplied as package insert, is lost, or following a firmware update from a version prior to V5.2, the activation key can be displayed locally on the Web Server under the menu:

Home> 0.2.150 OZW772.xx >Device information.

Log in

You must log in with user name and password each time.

The "operation" page of the portal is displayed.

Activate plant

A new plant is activated in the portal under menu "Administration" using the button [Activate Site].

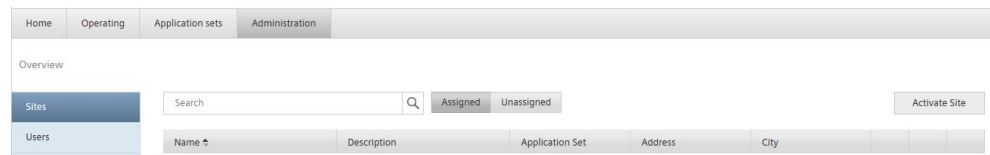

After entering the plant data, activate using the button [Activate].

The screenshot shows the 'Activating Site' form. It includes a 'New Activation Key' field with a placeholder 'xxxxxxxx-xxxx-xxxx-xxxx-xxxx'. The 'Name' field contains 'OZW SD2, Tenerife'. The 'Description' field is empty. Other fields include 'Address', 'Zip code', 'City', 'State', 'Country' (set to 'España'), 'Phone', and 'Timezone' (set to '(UTC) Dublin, Edinburgh, Lisbon, London'). An 'Activate' button is located in the top right corner of the form.

Activate additional plants

One user can activate multiple plants. The number is based on assigned roles. The workflow for activating an additional plant is the same as described under "Activate plant".

Query plant

In the "Operation" menu list the plant and can be queried by clicking the plant name.

The button [Web access] displays the user interface for OZW.

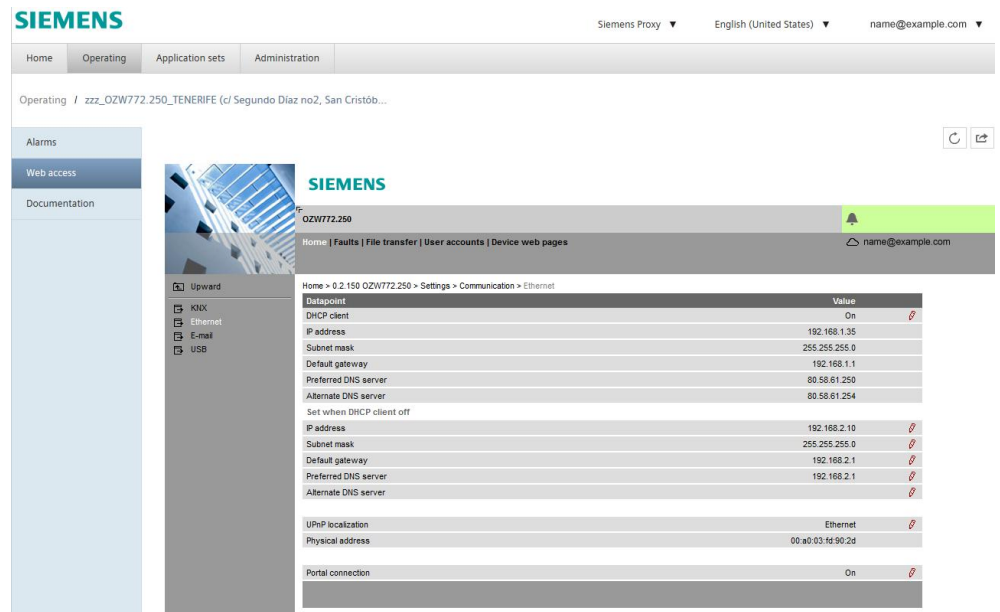

The screenshot shows the Siemens OZW772.250 web interface. The top navigation bar includes 'Home', 'Operating', 'Application sets', and 'Administration'. The 'Operating' menu is selected, and the plant name 'zzz_OZW772.250_TENERIFE (c/ Segundo Díaz no2, San Cristó...' is displayed. The left sidebar contains 'Alarms', 'Web access', and 'Documentation'. The main content area shows the 'Ethernet' settings page for '0.2.150 OZW772.250'. The page title is 'Home | Faults | File transfer | User accounts | Device web pages'. The settings are organized into a table with two columns: 'Datapoint' and 'Value'.

Datapoint	Value
DHCP client	On
IP address	192.168.1.35
Subnet mask	255.255.255.0
Default gateway	192.168.1.1
Preferred DNS server	80.58.61.250
Alternate DNS server	80.58.61.254
Set when DHCP client off	
IP address	192.168.2.10
Subnet mask	255.255.255.0
Default gateway	192.168.2.1
Preferred DNS server	192.168.2.1
Alternate DNS server	
UPnP localization	
Physical address	Ethernet 00:a0:03:4d:90:2d
Portal connection	On

Note



The user interface is opened in a new tab with button [🔗] and have the exact same view as the direct connection to Web Server without portal (local or via the Internet).

Operation is the same as described in Section 4.2, "Operate the plant".

3.1.1 Portal and plant roles

Portal roles

The portal role defines rights for portal settings, has users manage customers and assign roles.

Menu specific to the portal are displayed or hidden based on the portal role.

A detailed description of portal roles is available in the portal's documentation.

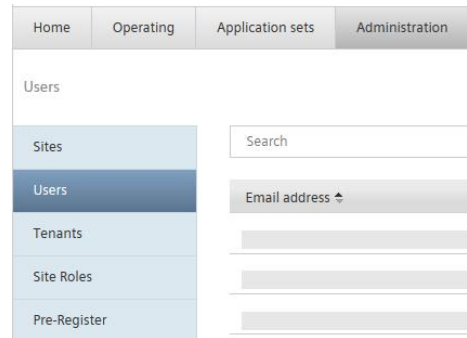

Note



A newly created user receives an e-mail with access data (link to portal, user name, password). A new password must be defined the first time a user log's on.

Plant roles

Each user is assigned a plant role that includes rights the owner possesses for the plant. A predefined plant role can be used or a specific one defined.

A detailed description of plant roles is available in the portal's documentation.

3.2 Prevent connection to portal

The portal connection can be switched off if you do not want a connection to the portal. Under path

<Home > 0.2.150 OZW772.xx > Settings > Communication > Services >

Is the data point "Portal connection".

The default setting is "On".

The setting "Off" does not connect to the portal, or an existing connection is cancelled.

Note



To prevent automatic log in to the portal during commissioning, the function must be previously switched off via USB prior to connecting the device to the Ethernet. The device logs on independently to the portal as soon as it has a connection to the Internet.

4 Operate using a web browser

This section describes how to operate the Web Server and connected devices.

4.1 Overview

Overview

The plant is operated via PC, smart phone or mobile phone with compatible web browsers (e.g. IE10+, FF18+) via USB interface, LAN/Ethernet or Internet (with or without portal).

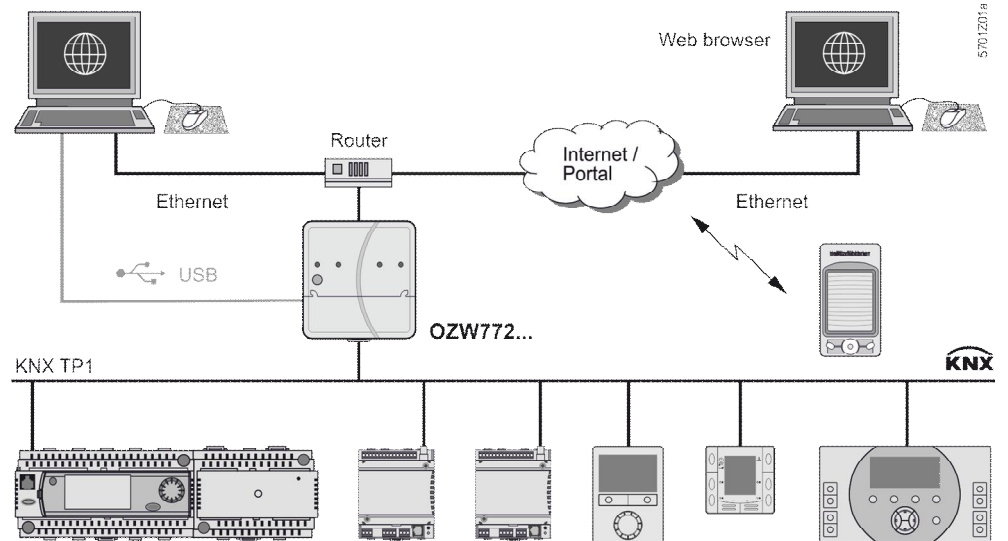

Connection

To access the portal, enter the address <https://www.siemens-syncoic.com>.

For access without portal, enter the IP address for the interface (USB, Ethernet) or the plant's domain name in the browser's address line.

Example of local connection via USB



Login

The login follows on portal or OZW:

- User name
- Password

Note



Detailed information on user name and password is available in Section 2.2.2 "Log into Web Server".

Incorrect log in for direct connection

The error message: "Authentication incorrect" after entering an invalid combination of user name and password.
The login is locked for this user name if an incorrect combination is entered 10 times within 5 minutes.
The next log in attempt displays the message "Temporarily locked".
Other user names can still log on during this period.

Note



The connection via the portal is not affected by the lock.

Logout

The web session logs out for security reasons 15 minutes after the browser is closed.

After 20 hours, the "absolute timeout" ends the session.

The function "Automatic log off" disabled the "absolute timeout". See the description in Section 2.5.3.3 "Communication", Section "Services".

Automatic log out occurs after 30 minutes of inactivity when using the portal.

Automate and "Deep Link" when accessing without portal

You can automate the process by adding the login information to the web browser's address line.

Format: <IP address>/main.app?user=<User name>&pwd=<myPassword>

Example: 10.169.9.121/main.app?user=Administrator&pwd=myPassword

Note



Only provide login information without private networks. Do not create "deep links" with login information on public networks.

"Deep link"

For access without portal, you can create and save a deep link to go to a sub-page without navigating. The easiest way to do this is to copy the URL for the desired subpage and replace the browsers session ID with user name and password.

Example

Original URL:

http://192.168.250.1/main.app?SessionId=f9d53187-2868-4a6b-8b20-9eca4e859a4d§ion=popcard&id=637&idtype=4

Available as "Deep Link":

http://192.168.250.1/main.app?user=Administrator&pwd=myPassword§ion=popcard&id=637&idtype=4

The current, valid login information must be included for syntax "user=<user name>&pwd=<myPassword>".

4.2 Operate the plant

Operate the plant

Device ready to operate are display via "Home".

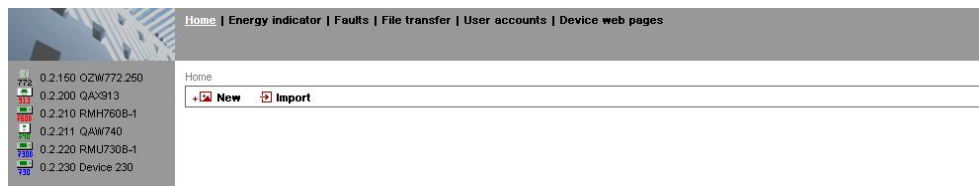

4.2.1 Operate Synco device

Operate Synco devices

Select the device in the left part of the menu to operate KNX devices. Web Server displays the top level of the menu tree. From here, you can go to all operating pages and data points.

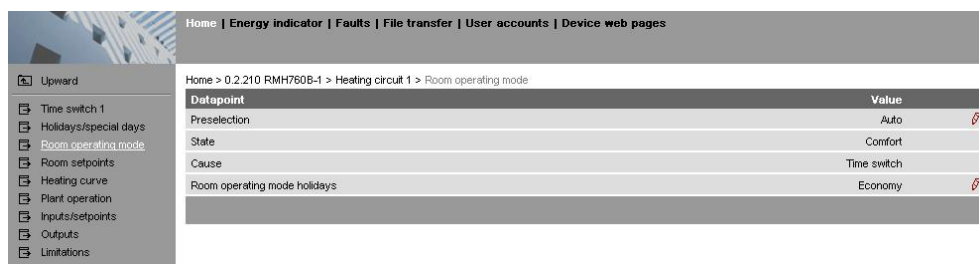

Operation of devices integrated via KNX S-Mode with ETS (Light, blinds, meters, etc.), is described in Section 10.2 "Operation KNX S-mode".

4.2.2 Operate Web Server

Operate Web Server

Click the left menu pane to select Web Server operation. Web Server displays the top level of the menu tree. From here, you can go to all operating pages and data points.

KNX pages defined with ETS are also displayed here.

Setting data on various operating pages is described in Section 2.5, "Web Server settings".

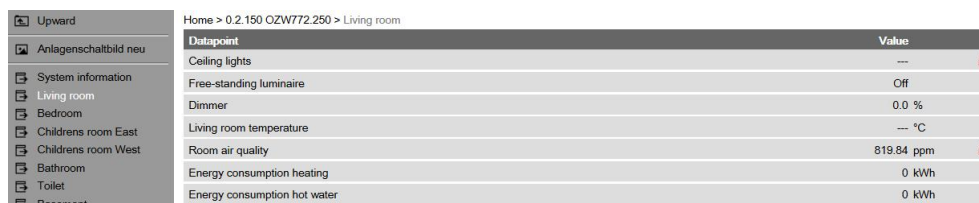

Switch views

Only the following parts of the user interface are displayed to operate the Web Server from a smaller screen or to hide navigation:

- Plant state
- Plant name
- Display

The double arrow in the upper left-hand corner switches the view.

Full screen

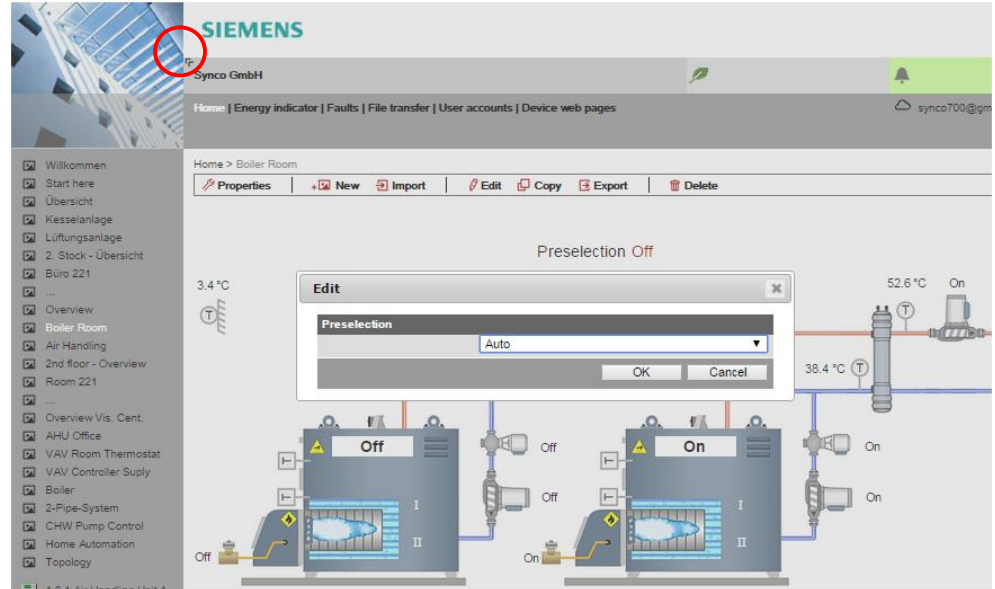

Partial screen



Note



In partial view, navigation to other plant web pages must be implemented using user-defined links. You can return to the full view at any time for navigation.

4.2.3 Web Server diagnostics

Diagnostics

The following information is required to identify product version and settings. Information on faults is available in Section 4.3.2.

Device information

The device information identified the Web Server.

Notes



Entries on the operating page "Device information" are for information purposes only and cannot be edited here.

Web Server

Path: Home > 0.2.150 OZW772.xx > Device information > Web Server.

Data point	Explanation, example		
Plant name	Web Server or plant name.	<input type="radio"/>	<input type="radio"/>
Web Server type	Web Server product number (ASN).	<input type="radio"/>	<input type="radio"/>
Fabrication number	Device number from production	<input type="radio"/>	<input type="radio"/>
System definitions	Version of the loaded system definitions	<input type="radio"/>	<input type="radio"/>
Software version	Web Server software version.	<input type="radio"/>	<input type="radio"/>
Build	Revision status for the software.	<input type="radio"/>	<input type="radio"/>
Hardware version	Web Server hardware version.	<input type="radio"/>	<input type="radio"/>
Message inhibition	Displays position of switch 8 "Message inhibition"	<input type="radio"/>	—
Activation key	Activation key for registering on the Synco IC portal	<input type="radio"/>	<input type="radio"/>

KNX

The following information displays the current settings and states on the KNX bus. The KNX settings are in Section 2.5.3, Operating page "Settings".

Path: Home > 0.2.150 OZW772.xx > Device information > KNX.



Data point	Explanation, example		
Area	First KNX network level. The line coupler assigns the area. The factory setting for the Web Server is set to area 0.	<input type="radio"/>	<input type="radio"/>
Line	Second KNX network level. The line coupler assigns the line. The factory setting for the Web Server is set to line 2.	<input type="radio"/>	<input type="radio"/>
Device address	The factory setting for the Web Server is set to device address 150.	<input type="radio"/>	<input type="radio"/>
Clock time mode KNX	"Master" or "Autonomous": Time is mapped from Web Server quartz. "Slave": the Web Server gets the time from the master clock.	<input type="radio"/>	<input type="radio"/>
Clock slave remote adj KNX	"Clock slave remote adj KNX" = "Yes" allows the Web Server to change the clock master time on the KNX network. "Yes" makes sense for "Time synchronization" = "Slave on bus".	<input type="radio"/>	<input type="radio"/>
Number of devices max	Maximum possible number of devices monitored by Web Server on the Synco bus.	<input type="radio"/>	<input type="radio"/>
Number of devices current	Actual number of devices monitored by Web Server on the Synco bus.	<input type="radio"/>	<input type="radio"/>
Last change	Time of last change to device list.	<input type="radio"/>	—

Ethernet

You can consult the following information as needed to analyze problems on the Ethernet. It displays the current settings for the subnet.

The Ethernet settings are made in Section 2.5.3, Operating page "Settings".

Path: Home > 0.2.150 OZW772.xx > Device information > Ethernet.

Data point	Explanation, example		
DHCP client	Displays whether the DHCP client is switched on.	<input type="radio"/>	<input type="radio"/>
IP address	Web Server IP address. The factory IP address for the Web Server on the Ethernet is: 192.168.2.10	<input type="radio"/>	<input type="radio"/>
Subnet mask	The subnet mask defines the size of the subnet. A value of 255 masks the partial network; a value of 0 masks the device portion of the IP addresses on the subnet. Devices must have the same partial network to communicate directly. The Web Server has a default subnet mask 255.255.255.0	<input type="radio"/>	<input type="radio"/>
Default gateway	The standard gateway connects the subnet for the Web Server to additional networks, e.g. the Internet. The router typically is the default gateway.	<input type="radio"/>	<input type="radio"/>
Preferred DNS server	Preferred DNS server required to send e-mails. The router is typically the DNS server as well for the Web Server.	<input type="radio"/>	<input type="radio"/>
Alternate DNS server	An alternative DNS server is only defined for redundant systems and is typically empty.	<input type="radio"/>	<input type="radio"/>
Physical address	The physical address (MAC address) is a unique identification for the Ethernet interface.	<input type="radio"/>	<input type="radio"/>

Setting for DHCP client off



Alternative settings are used for the following when the DHCP client is switched off:

- IP address
- Subnetmask
- Standard gateway
- Preferred DNS server
- Alternative DNS server

Services

The following information displays the current serve settings.
The service settings are made in Section 2.5.3, Operating page "Settings"

Path: Home > 0.2.150 OZW772.> Device information > Services

Data point	Explanation, example		
ACS access	With "On" access to ACS operating software is permitted on the Web Server. With "Off", there is not access (only via direct connection – not possible via the portal).	<input type="radio"/>	<input type="radio"/>
Web access via http	With "On" access is permitted with http and https. With "Off" access is only permitted with https.	<input type="radio"/>	<input type="radio"/>
UPnP localization	UPnP localization can be disabled (---) or set on Ethernet or USB.	<input type="radio"/>	<input type="radio"/>
ETS access via KNXnet/IP	"On" permits access to the plant using the ETS software via KNXnet/IP. "Off" does not permit access (only via direct connection – via portal is not possible).	<input type="radio"/>	<input type="radio"/>
Portal connection	With "On" data exchange with the portal is activated. With "Off" there is no exchange of data.	<input type="radio"/>	<input type="radio"/>
Automatic log off	"Absolute timeout" automatically disconnects to the Web Server after 24 hours.	<input type="radio"/>	<input type="radio"/>

4.3 Faults

4.3.1 Overview

Fault overview

The "Faults" function displays the most severe fault on a Synco device in the device list. It is available to all user levels. The following information helps identify the fault:

- Fault
- Device name
- Fault information (date, time, fault code).
- Fault text
- Device address
- Device type

Home Faults File transfer User accounts Device web pages Service [Logout]					
Fault	Device name	Fault information	Fault text	Device address	Device type
 Fault 1	Device	30.11.2009; 13:27; 3920	Frost	0.2.246	RMU710B-1

Notes



- An overview of Web Server faults is available in Section 11.2.1.
- Faults for Synco devices are listed in the documentation for the corresponding devices.
- Click  to go to the corresponding device's web operation.



4.3.2 Device faults

You can display detailed information on all faults via the "Home" menu.

Local faults

Displays all faults for the OZW772...

Path: Home > 0.2.150 OZW772.xx > Faults current > Local





Data point	Explanation, example		
Fault 1..10	Displays for each fault: <ul style="list-style-type: none"> • Fault information (date, time, fault code). • Fault text 	<input type="radio"/>	<input type="radio"/>
Acknowledge faults Default val: No Setting val: Yes / No.	The setting value "Yes" acknowledges Web Server faults (same effect as "Remote" ✓). Setting value "Yes" is a temporary state, i.e. the setting value automatically goes to "No" after ca. 2 seconds.	<input checked="" type="radio"/>	<input checked="" type="radio"/>

Home > 0.2.150 OZW772.04 > Faults current > Local	
Datapoint	Value
Fault 1	
Fault information	07.01.2005; 15:47; 5000
Fault text	No bus power supply
Fault 2	
Acknowledge faults	No 

System faults

The most severe faults are displayed for each device on the KNX bus.

Path: Home > 0.2.150 OZW772.xx > Faults current > System > Fault 1...n

Data point	Explanation, example		
Fault 1..n	Displayed under "Fault 1..n": Device name, Fault information, Fault text, Area, Line, Device address, Device type		

Note

-  Faults for Synco devices are listed in the documentation for the corresponding devices.

4.4 File transfer

"File transfer":

- Downloads consumption data
- Download message history as Excel or text file
- Upload documents to the Web Server
- Upload logos
- Upload system definitions

Create and manage trend functions

Creating and managing trend functions is described in Section 9 "Trend functions".

Download consumption data

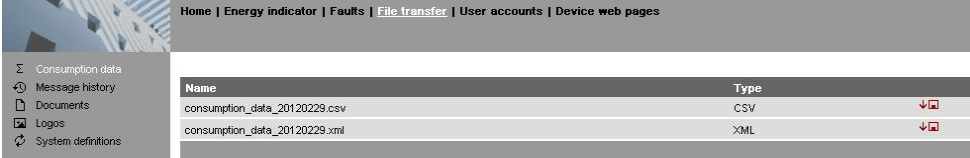

Name	Type	
consumption_data_20120229.csv	CSV	Download icon
consumption_data_20120229.xml	XML	Download icon

Note

-  The file can also be sent by e-mail, in addition to the download of consumption data described here.

Proceed as follows:

1. Select File transfer in primary navigation.
2. Click  depending on the desired output format for CSV or XML. The file download dialog box is displayed.
3. Open the file with the application or save it to any location.

Notes

- 
- The consumption data file is mapped at the moment it is opened.
 - The CSV is suitable for processing using any program that work with comma separated data.
 - The XML format is suitable for processing with MX Excel or Excel-compatible programs.

The design of the allocation file is explained in Section 6.

Download message history

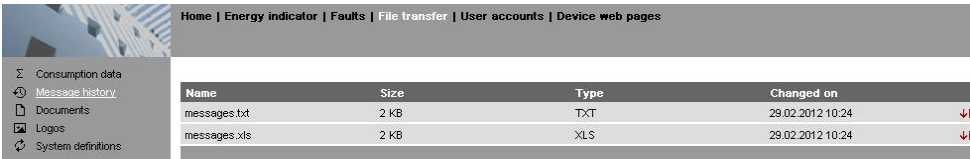

Name	Size	Type	Changed on	
messages.txt	2 KB	TXT	29.02.2012 10:24	Download icon
messages.xls	2 KB	XLS	29.02.2012 10:24	Download icon

Procedure:

1. Select "Message history" from secondary navigation.
2. Click  for the desired document. TXT for text or ASCII format and XLS for Excel format. The "File download" dialog box opens.



3. Open the file with the application or save it to any location.

Notes



- Message history export is available to administrator and service user levels.
- The message history remains intact when resetting the Web Server to default.

History data

The message history includes the last 500 events on faults, fault messages, and system reports. It contains the following information:

- Plant information:
 - Plant name
 - Phone number plant (Unused)
- Information per entry:
 - Event
 - Plant section (Device name (KNX bus address))
 - Date of occurrence
 - Time of occurrence
 - Fault code+text
 - Transmission date
 - Transmission time
 - Message receiver
 - Cause

Plant name	OZW772.01							
Phone number plant								
Event	Plant section	Date of occurrence	Time of occurrence	Fault code+text	Transmission date	Transmission time	Message receiver	Cause
Fault going	OZW772.01 (0.2.150)	*2009.06.24	*15:42:26	5003: Invalid time of day				
Message not OK	OZW772.01 (0.2.150)	*2009.06.24	*15:42:26	5023: M'rec 1 not reached	*2009.06.24	*15:42:38	1: myservice@siemens.com	Fault receiver
Message not OK	OZW772.01 (0.2.150)	*2009.06.24	*15:42:26	5023: M'rec 1 not reached	*2009.06.24	*15:42:43	1: myservice@siemens.com	Fault receiver
Fault going	OZW772.01 (0.2.150)	*2009.06.24	*15:46:29	5023: M'rec 1 not reached				
Fault coming	OZW772.01 (0.2.150)	*2009.06.24	*16:20:30	5001: System time failure				
Fault coming	Appartment Unit (0.2.100)	*2009.06.24	*16:57:29	5031: Radio comm error				
Fault coming	Appartment Unit (0.2.100)	*2009.06.24	*17:27:10	5031: Radio comm error				
Fault going	Appartment Unit (0.2.100)	*2009.06.24	*17:35:57	0: No fault				
Fault going	OZW772.01 (0.2.150)	*2009.06.24	*17:47:25	5001: System time failure				
Message not OK	OZW772.01 (0.2.150)	*2009.06.26	*16:10:54	OK	*2009.06.26	*16:11:09	1: myservice@siemens.com	Fault receiver
Fault coming	OZW772.01 (0.2.150)	*2009.06.26	*16:15:42	5000: No bus power supply				
Fault going	OZW772.01 (0.2.150)	*2009.06.26	*16:16:52	5000: No bus power supply				

Upload documents

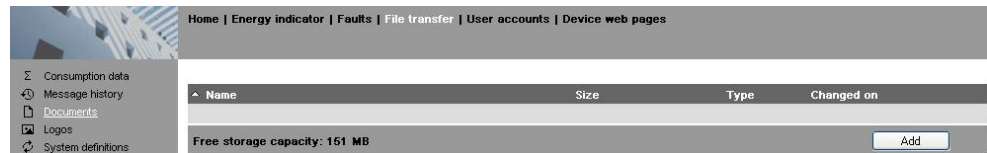

Procedure:

1. Select File transfer in primary navigation.
2. Select documents in secondary navigation
3. Click [Add]

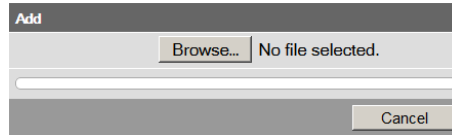

4. Click [Browse] and select desired file.
5. The upload starts directly after selecting the desired files and clicking [Open].

Notes



- Make sure there is enough memory for uploading.
- The Administrator and Service levels allow for uploading documents.

Upload logos

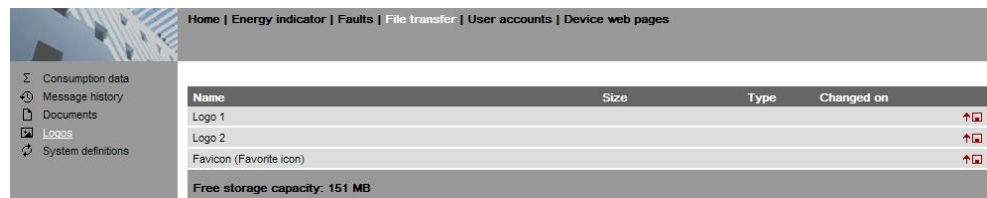

Procedure:

1. Select l from secondary navigation.
2. Save existing logo(s) as needed (see below).
3. Click



4. Select the desired file.
Adhere to maximum dimensions (see Notes).
5. Click [Upload]
6. Re-load page content from Web Server (Internet Explorer, Firefox: Ctrl+F5; i.e. no older data is displayed from the browser cache)

Save logos:

1. Click "Logo 1" or "Logo 2". The browser window opens with the logo.
2. Right-click the log and save to the desired location via "Save Image As".

Notes



- Log file transfer is available to administrator and service user levels.
- Allowed file formats: PNG, GIF, JPG, BMP.
- The left logo (Logo 1) has max. 625 x 54 pixels.
- The right logo (Logo 2) has max. 200 x 54 pixels.
- The original logos are restored when resetting the Web Server to default.
- The area belonging to the logo is highlighted in color when the cursor moves within the display area above the logo line.

Upload system definitions

The currently installed version of system definitions can be viewed under "Current version". There are three elements separated each time by a period, e.g. "2.1.0". The middle section (in the example "1") is also displayed in the device information.

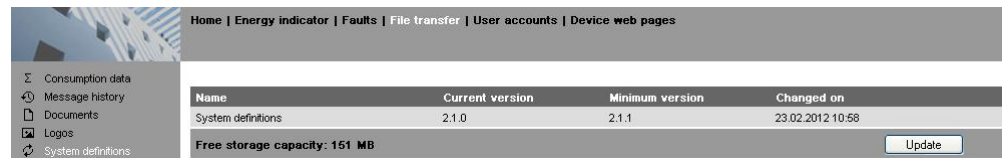

Name	Current version	Minimum version	Changed on
System definitions	2.1.0	2.1.1	23.02.2012 10:58

Free storage capacity: 151 MB Update

Procedure:

1. Select System definitions from secondary navigation.
2. Click [Update]

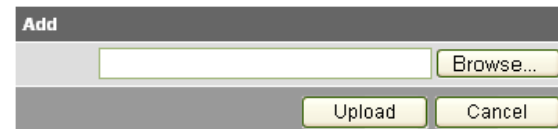

Add

Browse...

Upload Cancel

3. Select the desired file.
4. Click [Upload] to finish.
5. Upload is finished when the message "Update - Process finished" displays.
6. You must recreate the devices following a system definition upload.

Notes



- System definition file transfer is available to administrator and service user levels.
- Uploading and installing make take more than 15 minutes.

System definitions

System definitions comprise:

- Device descriptions.
- Text catalogs in each user language.
- Units catalog.

The device web pages use the uploaded system definitions to properly display devices and menus.

You must generate all device web pages following successful uploading. This applies the new system definitions.

The system definitions must be compatible with the Web Server's software version. If incompatible, an associated message is displayed and the old system definitions remain as is.

Note



Make sure there is at least 60 MB free memory on the Web Server when uploading. If not, check the contents via File transfer > Documents.

4.5 Operation with ACS790

The following functions are available with ACS790:

- Commissioning with device search.
- Popcard.
- Plant diagrams:
For standard applications for the Synco devices, web-capable plant diagrams may be exported from ACS790 and import them to the Web Server.
- Parameterization:
Read and write parameter sets.
(the parameter set of the OZW772... contains the device list of the OZW772..., too)
- Commissioning protocol.
- Offline trend.

For more details, see data sheet N5649.

5 Visualize plants

5.1 Overview

Web Server OZW772... visualizes technical equipment in buildings (HVAC, electrical, energy values) via plant web pages. The plant is operated and monitored via one or more generated plant web page(s).

Download plant diagram	Web-capable plant diagrams can be downloaded from the HIT (HVAC Integrated Tool by Siemens) online platform for Synco 700 devices, RXB/RXL room controllers and RDG/RDF/RDU room thermostats standard applications.
Create own plant web pages	You can freely design plant web pages. As a hybrid form, you can also modify and extend downloaded plant diagrams.
Web page elements	Plant web pages are designed with the following web page elements: <ul style="list-style-type: none">• Background image• Data point elements• Text elements• Link elements• Partial pictures <p>Data point elements are used to operate and monitor read and write values for devices connected via KNX and the Web Server.</p>
Edit / view mode	Plant web pages are generated online in the web browser. The web page designer with administrator rights also switches the plant web pages to edit mode. Other users can query and operate the last saved visualization during the transition phase. Plant web pages return to view mode once the changes are saved. The new state is now available online at this point.

5.2 Example of a plant web page

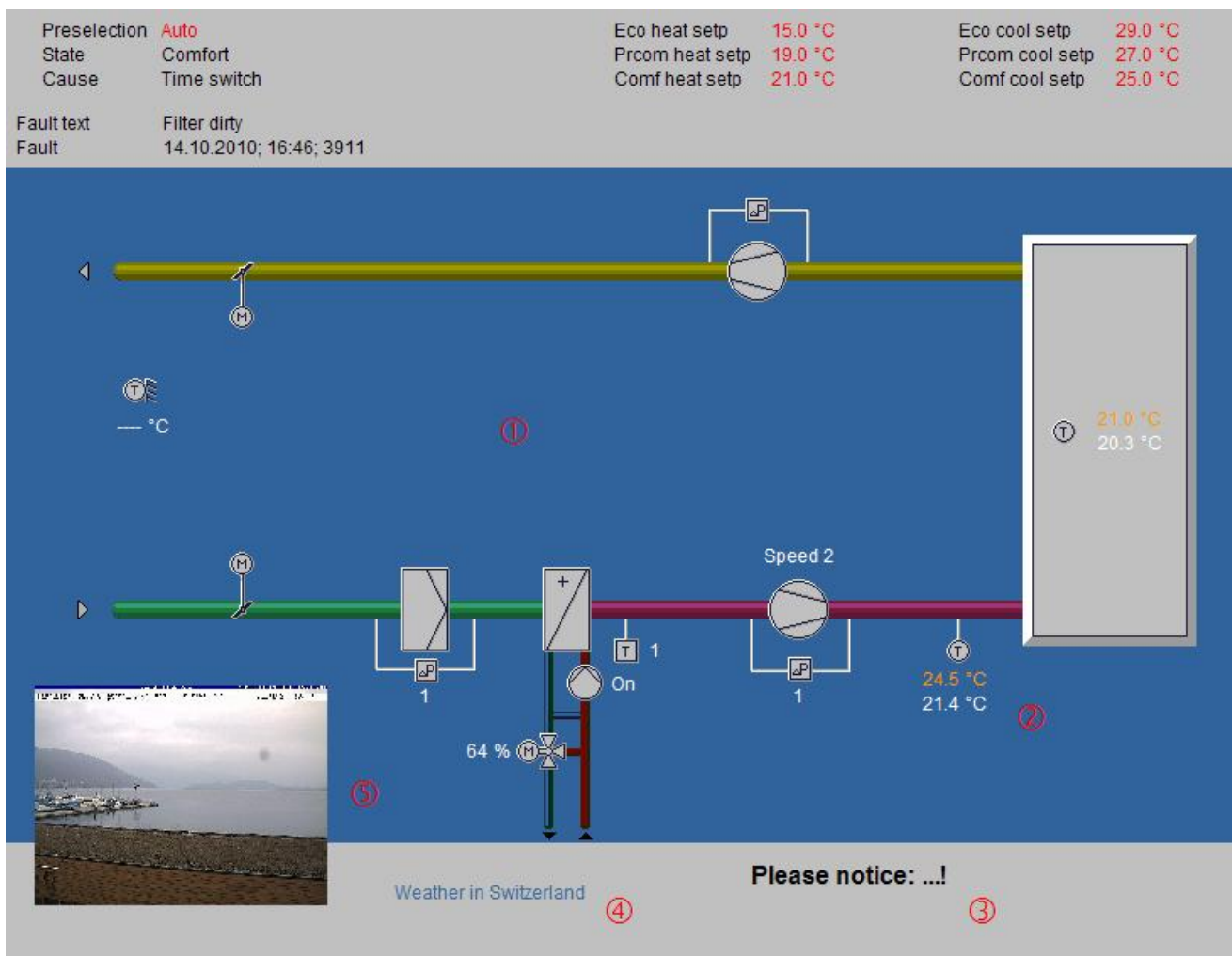

- ① **Background image** All surfaces, symbols and the diagram.
- ② **Data point element** Two data point elements: Present supply air setpoint (orange), supply air actual value (white).
- ③ **Text element** Explanation text.
- ④ **Link element** Link to Internet.
- ⑤ **Part. pic. element** Integrated web cam image.

The example above is an extension to a web-capable plant diagram downloaded from HIT.

The extension consists of additional, explanatory text (3), a link to the Internet (4) and an integrated web cam image (5), that is updated periodically (every minute).

As of OZW version 5.0, data points are also available on devices integrated via KNX S-Mode for display on the plant diagram (Light, blinds, energy volume meters, etc.). See Section 10 "KNX S-Mode".

5.3 Plant web page features

Background image

A plant web page has an expandable area that can be used to place web page elements. The display area has a minimum size of 800px (width) and 580px (height).

The minimum display area is filled with a transparent background image if no background image is explicitly selected.

- The display area can be expanded to any size by adding a larger background image.
- The following types are accepted: png, jpg, gif and bmp; we do not recommend using bmp due to the file size.

Position in secondary navigation

Multiple plant web pages are listed from top to bottom in the secondary navigation per their "Position". The plant web page is built and displayed at "Position"=1 when going to a home or device node. Use "Position > New > Properties" to set the "Position" in the secondary navigation or "Properties > Position" for existing plant web pages.

Front side / Background

The following applies to levels within a plant web page:

- The background picture is located in the background.
- The group of partial pictures are in front.
- The group with all remaining elements are in front.
- More recently added elements are on top of previously added elements within the group of partial pictures and remaining elements.

Please note the following for the last statement:

- If **an** element is deleted as part of editing and another element added, the new element jumps to the level of the deleted one. This level is not always the top level.
- You must add a new element as part of **new** editing to ensure that the new elements are placed at the top (finish with OK and re-click edit).

Show / Hide

Plant web pages are hidden for a hidden device with appended plant web pages. The associated plant web pages are displayed again if the device is re-generated and displayed (Important note in Section 2.8).

Delete

Appended plant web pages are irretrievably deleted once a device is deleted. The same is true when you reset the Web Server.

Changes to controller configuration

Any change to the controller configuration creates differences between the controller and the mapping on the Web Server. This impacts plant web pages as well where data point elements access the controller via the Web Server map. You must run "Generate" each time you change the controller configuration (see Section 2.4 for workflow).

Key variables

Any number of plant web pages per Web Server are possible.

- The Web Server has 180 MB in memory.
- You should pay special attention to image file size to save memory; (current available memory is available at "File transfer > Documents").
- A maximum of 100 elements may be added on a plant web page from one web page element type (e.g. a maximum of 100 data point elements).

5.4 Toolbar

Note

The menus described below are only displayed and operable on the "Administrator" user level.

View mode, no web page available

The following toolbar is displayed at home and on the device nodes, if no plant web pages are generated:

Home > 0.2.150 OZW772.16



Menu	Description (in German)
New	Create new plant web page.
Import	Import archived plant web page. Plant web pages are archived and imported as .tar files.

View mode, web page available

The toolbar is as follows for an existing plant web page:

Home > RMU710B_A01_ADA001BHQ



Menu	Description (in German)
Properties	Properties dialog for the plant web page. Enter the same as for "New". Furthermore, "Replace data point addresses" address identical data points on another device (KNX address).
New	Create another plant web page.
Import	Import archived plant web page.
Edit	Switch to edit.
Copy	Copy selected plant web page to another device node.
Export	Export selected plant web page as .tar archive.
Delete	Deleted selected plant web page.

Edit

Click Edit to switch the plant web page to edit mode. The toolbar is as follows:

Home > RMU710B_A01_ADA001BHQ



Menu	Description (in German)
Data point	Embed data point element to web page. A data point element consists of two fields: <ul style="list-style-type: none"> Data point value for a device connected via KNX or the Web Server. Data point text.
Text	Add free text (single line) to plant web page. The text is entered in the field "Displayed name".
Link	Hyperlink to other plant web pages, to a document or an external web page.
Partial picture	Add additional picture to plant web page. "Link external" integrates periodically updated, external images (e.g. web cams).

User levels

Only an administrator may generate and change visualization. User levels have the same rights for operation and monitoring.

5.5 Import web-capable plant diagrams

HIT has web-based plant diagrams for download and import to the Web Server for Synco 700 standard applications as well as the room controllers RXB and RXL.

Prerequisites

- The drafter is logged on to the Web Server as an administrator.
- The Web Server is connected via KNX with one or more devices (Synco 700 devices, room controllers).
- A standard application is loaded on the device.
- The device web page is generated, see Section 2.4. The Web Server menu tree and data point information for the device and the loaded standard application are now available.

Download plant diagram from HIT

Workflow in HIT online platform (Siemens HVAC Integrated Tool):

1. Run www.siemens.com/hit.
2. Select country.
3. Select "Applications" in HIT.



4. Select application (heating, ventilation/air conditioning, refrigeration, rooms).
5. Select a standard application for the Synco 700 series (e.g. ADA001 U1B HQ) or a room controller application (RXB, RXL) in the "Rooms" application.
6. Click document symbol in the "Doc" column.

Application no.	Doc
A00001 MS0 HQ	
A00001 S0B HQ	
ADA001 U1B DE	
ADA001 U1B HQ	
ADA002 U1B HQ	

The dialog "Application documents" is displayed.

7. Click the ZIP symbol on the line "Plant diagram for operator station (ACS and OZW)".

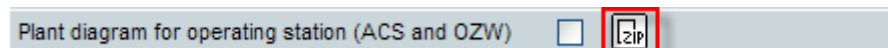

The file download dialog box is displayed.

8. Click Open.
The ZIP program opens the ZIP archive.
9. Drag and drop the .tar file to the computer.
10. Close ZIP archive and HIT download dialog box.
This saves the .tar file with the web-based plant diagram on the computer.

Import plant diagram to Web Server

Workflow on Web Server:

1. Start at the home node in secondary navigation, select the Synco controller.
2. Click Import.
The import dialog ("file name (*.tar)") is displayed.
3. "Search..." to go to the .tar file saved on the computer.
4. Click Open.
5. Click Upload.
Import information is displayed while the file is being read; the property dialog box now opens.
6. Check "Replace data point addresses".
7. From the dropdown menu, select the KNX address for the controller connected via KNX and used to load the standard application.

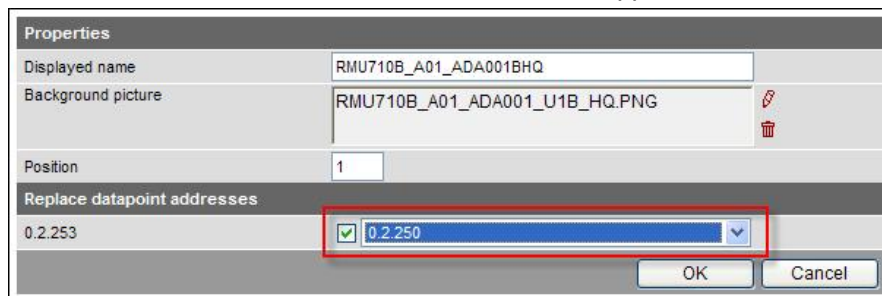

8. Click [OK] to start.
The plant diagram is finished.

Result

The controller or plant can now be operated and monitored via the web-based plant diagram. The default display is as follows:

- Operating values (e.g. operating mode Auto, Comfort, PreComfort, etc.) is displayed in red. The cursor changes to a hand symbol when you move it over the display. Click to open the applicable settings dialog box.
- Set points are displayed in orange; actual values in white.

Note

It may occur that individual data points for controllers cannot be mapped to the standardized plant diagram due to compatibility issues.

- The data point text "Data point not found" is displayed.
- Three question marks "???" are displayed as the data point value.
See Section 5.6 for any post editing.

5.6 Create own plant web pages

You can generate complete plant web pages yourself. As an option, you can change and extend any imported plant diagrams (see Section 5.5) as needed. This section presents the steps required to generate and design a customized plant web page.

Prerequisites

- The drafter is logged on to the Web Server as an administrator.
- The Web Server is connected via KNX with one or more devices.
- The device web pages for the Web Server and devices are generated, see Section 2.4. The Web Server menu tree and data point information is now available.

Create plant web page

The following describes how to create a plant web page and add a background image.

1. Go to home nodes or to a device node.
2. Click New.
The properties dialog box is displayed.
3. In the Displayed name field, enter the name for the plant web page (is displayed later in the navigation area for the Web Server).
4. Click the red pencil in the Background picture field.
The add dialog box is displayed.
5. Search to go to the desired background picture.
6. Click Open.
7. Click Upload.
The file name for the selected picture is displayed in the background picture field.
8. Click OK.
The plant web page is now saved with the background picture.

Note

The anchor for the X/Y position of the background image is fixed on the plant web site in the full image at 180/194 pixels (left top corner of the image). This corresponds to 10/86 pixels in the partial view.

Add data point element

The following describes how to add a data point element to a newly created plant web page.

1. Click Edit.
The plant web page switches to edit.
2. Click Data point.
The data point dialog box is displayed.
3. Click the red pencil in the Data point address field.
The data point address dialog box is displayed.
4. Go to the data point via device, menu text(s).
5. Select Data point.
The entire data point path is entered in the data point address field.
6. Set the X/Y position for the data point field in the display area.
7. Modify formats such as text field size for "Data point" and "Data point" as needed.
8. Click Apply to check the results of the change in formatting as a preview to the plant web page.
9. If satisfied, click OK to finish.
10. Click OK to change to view.
The data point value was read and is displayed.

Notes

- Double-click the data point element in edit to reopen the settings dialog box for an already created data point element. The data point element can also be deleted in the settings dialog box.
This note applies as well to other web page elements.
- As an alternative to setting the X/Y position in the data point dialog box, you can also position data point elements using drag and drop in edit mode. The element can no longer be moved after switching to view mode.
This note applies as well to other web page elements.
- The X/Y position in the data point dialog box is anchored to the text in the data point value field and its alignment. In conjunction with the alignment functions, the data point field moves to the right for left align and to the left for right align (see the following graphic).
This note refers as well to text and link elements accordingly.

Alignment

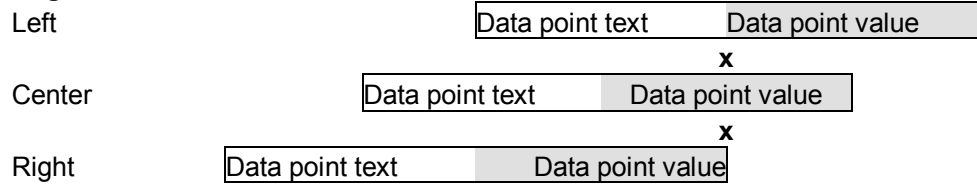

Notes

- The "x" displays the changed position of the anchor.
- The alignment of all the data point texts is left aligned.

Add text element

The following describes how to add informational text to a plant web page.

1. Click Edit.
The plant web page switches to edit.
2. Click Text.
The text dialog box is displayed.
3. Enter the desired text in the Displayed name field.
4. Set the X/Y position for the text field in the display area.
5. Format as needed.
6. Click Apply to check the results of formatting in a preview.
7. If satisfied, click OK to finish.
8. Click OK to change to view.

Notes

Text elements are single lines.

Only a limited number of fonts are available for texts:

- Small 10pt
- Normal 12pt
- Large 16pt
- XL 24pt

Add link element

The following describes how to add two lines to the plant web page:

- To another plant web page.
- To an external web page.

The link to a document is not displayed, but works accordingly.

Link to another plant web page

1. Click Edit.
The plant web page switches to edit.
2. Click Link.
The link dialog box is displayed.
3. Enter the desired text for display in the Displayed name field.
4. Select Link to in the "Plant diagram" field.
5. Click the red pencil in the same field.
The plant diagram dialog box is displayed with all plant diagrams available on the Web Server.
6. Select the desired plant diagram.
Enter the path for the plant diagram in the "Link to" field.
7. Set the X/Y position for the link field in the display area.
8. Format the link as needed.
9. Click Apply to check the results of formatting in a preview.
10. If satisfied, click OK to finish.
11. Click OK to change to view.
The link is enabled immediately in the view mode: Click to open the corresponding plant web page.

Tip

We recommend adding a link on the target web page to return to the previous page.

Notes

- Links are broken after importing a plant web page to another Web Server and must be restored per the instructions above.
- The links to other plant web pages are also broken after a firmware update for web pages exported in advance and then imported and must be restored per instructions above.

Links to an external web page

1. Click Edit.
The plant web page switches to edit.
2. Click Link.
The link dialog box is displayed.
3. Enter the desired text for display in the Displayed name field.
4. Select external link in the Link to field.
5. Click the red pencil in the same field.
The link external dialog box is displayed.
6. Enter the desired URL.
7. Check the correctness of the entry: The Internet page is opened.
8. Confirm with OK.
9. Enter the URL in the "Link to" field.
10. Format the link as needed.
11. Click Apply to check the results of formatting in a preview.
12. If satisfied, click OK to finish.
13. Click OK to change to view.
The link is enabled immediately in the view mode: Click to open the corresponding web page.

Add partial picture

The following describes how to add two partial pictures to the plant web page:

- A static picture downloaded to the Web Server.
- A link to an external picture on a server, e.g. continuously updated images from a webcam.

Static partial picture

1. Click Edit.
The plant web page switches to edit.
2. Click Partial picture.
The partial picture dialog box is displayed.
3. Select "Picture source" in File field.
4. Click the red pencil in the same field.
The add dialog box is displayed.
5. Click Search.
6. Go to desired image file.
7. Click Open.
8. Click Upload.
Enter the file name for the selected image in the Field Source field.
9. Adapt Position and Scaling.
10. Click Apply to check the results of formatting in a preview.
11. If satisfied, click OK to finish.
12. Click OK to change to view.

Dynamic partial picture

1. Click Edit.
The plant web page switches to edit.
2. Click Partial picture.
The partial picture dialog box is displayed.
3. Select "Picture source" in Link external field.
4. Opens the web cam image on the Internet.
5. Right-click webcam image.
6. Select properties for webcam image.
7. Highlight the address (URL) of the webcam image and copy to clip board.
8. Click the red pencil in the Source Picture field.
The link external dialog box is displayed.
9. Add the URL for the webcam image.
10. Check the correctness of the entry: The webcam image is opened.
11. Click OK.
12. Modify Position and Scaling.
13. Click Apply to check the results of formatting in a preview.
14. If satisfied, click OK to finish.
15. Click OK to change to view.

6 Record consumption data

You can record consumption data for heating, hot water, chilled water, cooling electricity, natural gas or other media depending on the installed energy or volume meters. You can precisely track energy consumption by querying consumption data. Daily updated values, monthly values and for QAX9... annual due date values are available.

OZW772... as of version 5.0

Energy and volume meters that use KNX data points are also supported as of integration of KNX S-Mode as of Web Server version 5.0.

The meters can be connected directly or via KNX adapter to the KNX bus and transmit their data as per the configuration in ETS "Configuration in KNX S-Mode", see Section 10.1.

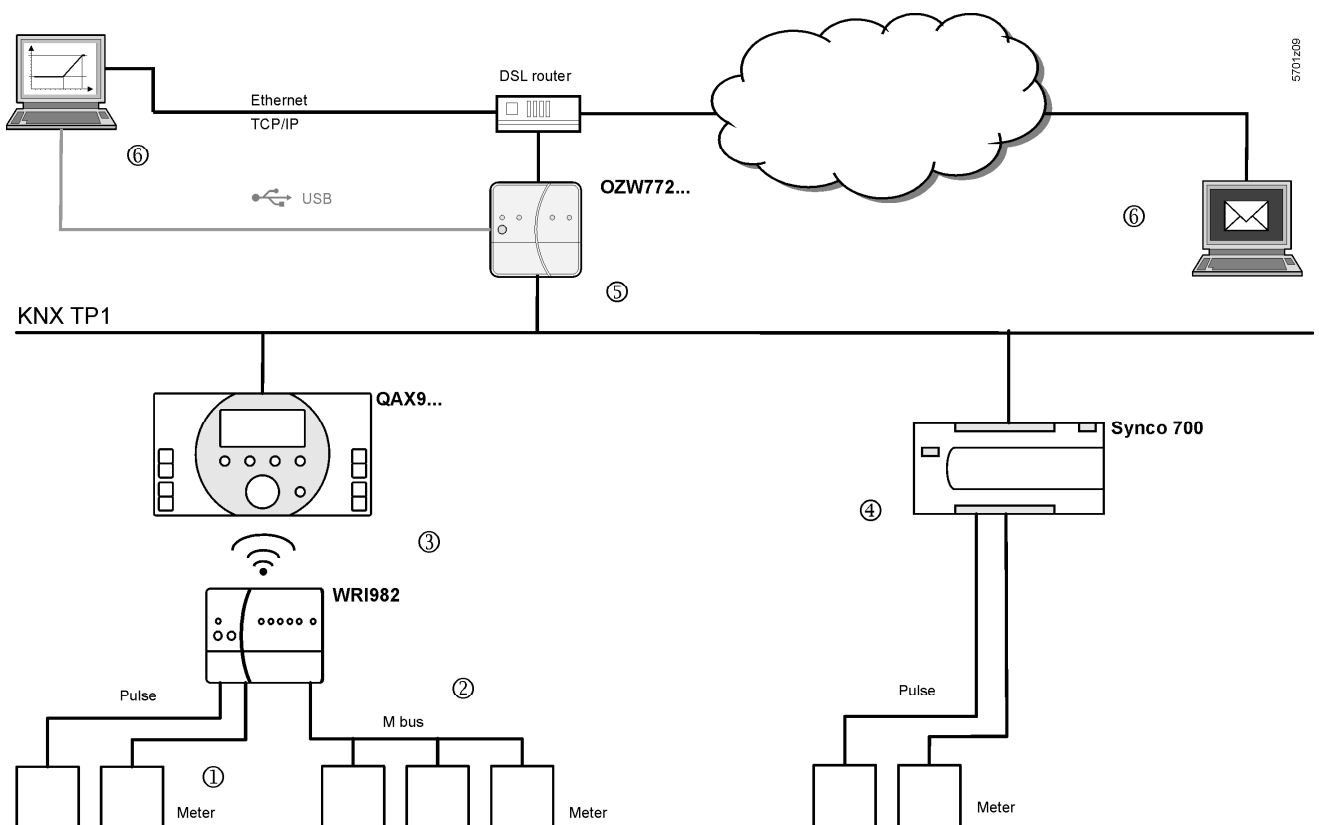

- ① The consumption data interface WRI982 continuously counts pending pulses.
- ② The WRI982 periodically queries consumption data on the M-bus meter.
- ③ The QAX9... periodically queries the consumption data interface WRI982.
- ④ The Synco 700 controller continuously counts pending pulses.
- ⑤ The OZW772... periodically queries consumption data.
- ⑥ You can view consumption data via web operation (local or remote) or have it send by e-mail.



- Compatible M-bus meters are listed in data sheet N2735 on the consumption data interface WRI982.
- The QAX9.... documentation includes additional information on meter integration and consumption data acquisition up to QAX9...
- Information on pulse processing for Synco 700 controllers is available in the corresponding documentation on basic.
- Information on KNX S-Mode products is available in the manufacturer's product documentation.

6.1 Consumption data file

You can view the consumption data file via web operation (local or remote) (Section 4.4) or sent via e-mail (Section 6.3).

The consumption data file displays meters for those KNX devices with device pages generated on the Web Server.



The device web pages must be re-generated after commissioning and changes to the plant (see Section 2.4).

Static metering information is available immediately after generation. The current values for operational meters are available in the consumption data file at the latest after 24 hours.

6.1.1 Main areas for consumption data file

my header						
Plant information						
Plant name	Device address	Device type	Serial number	IP address	File created on	
OZW772.04	0.2.150	OZW772.04	00FD00FEFF0C	192.168.251.1	10:29	04.01.2011
Meter data						
Device information			Meter information			
Device name	Device address	Device type	Serial number	Meter name	Medium	Production r
QAX913	0.2.200	QAX913-1	00FD0001889E	Electricity 1	Electricity	569
QAX913	0.2.200	QAX913-1	00FD0001889E	Heat/cooling energy 1	Heat (outlet)	569
QAX913	0.2.200	QAX913-1	00FD0001889E	Cold water 1	Cold water	5474166
QAX913	0.2.200	QAX913-1	00FD0001889E	Hot water 1	Hot water	5474167
Heizung	0.2.210	RMH760B-1	00FD00019940	meter 1		
Meter replacement						
Device information			Meter information			
Device name	Device address	Device type	Serial number	Meter name	Medium	Production r
my information line 1						
my information line 2						
my footer						

Header, Information line 1...10 and Footer are user defined settings that can be entered in the web operation for the Web Server (see Section 2.5.3.6, "Consumption data").

Plant information relies on the Web Server and is mapped "ad hoc" when querying and sending the consumption data file.

Meter data

Meter data is mapped in the Web Server based on information from Synco devices entered and generated under Device web pages.

Meter exchange

The entire data set for the meter is moved when replacing a meter from the "Meter data" area to "Meter replacement".

In generation, the "Meter replacement" function ensures that last available values for any meter is retained even for billing purposes even after replacement.

Notes



- The entire "Meter replace" area can be deleted (see Section 2.5.3.6, "Consumption data").
- 2-year old data is deleted automatically.

6.1.2 Meter data in detail

Key for data fields:

A	Web Server data (plant)	F1	Last due day
B	Device information (incl. meter name)	F2	Last but one due day
C	Meter information (excl. meter name)	G	Calendar monthly values
D	Current values	H	Start value Web Server
E	Meter state	T	Header
		U	Information lines
		V	Footer

QAX / Synco 700 data

Data for device information, including meter name (data field B) are mapped to the Web Server based on information from the Synco devices immediately after generating.

Note



Must be re-generated if settings are changed to integrated Synco devices.

QAX / Synco 700 mapping

Meter information, not including meter name (data field C), current values (D), meter status (E), last due date (F1) and calendar monthly values (G) are collected at the QAX9... or on the Synco 700 controller (not E and not F1) and then retrieved by Web Server.

Note



Data in the section on meter status (E) are specific to the manufacturer for M-bus meters.

Initialize QAX9...

The listed values are available for the first time on the QAX9...:

- For initial commissioning: After the connection test of WRI982 or automatically after 4 hours.
- For meter replacement: After two connection tests of WRI982 or automatically after 8 hours.

Web Server constructs

- Web Server copies data to "Last but one due date" (F2) from "Last due date" each time a **new** "Last due data" is read from QAX9....
- Web Server maps the data in "Start value Web Server" (H) as soon as it receives the first measured value from each meter.

6.2 Time ratios

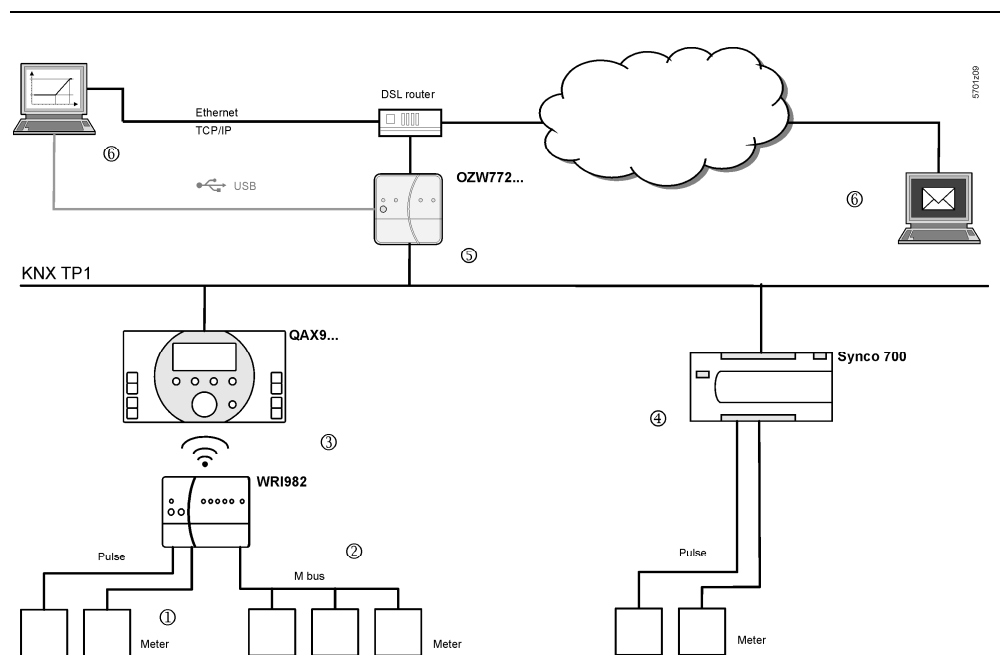

Current value

Meter → WRI982

- Consumption data from pulse meters is added up **once an hour** on WRI982.
- Consumption data from M-bus meters are read by WRI982 **every 4 hours**.

WRI982 → QAX9...

QAX9... reads the current values pending on WRI982 **every 4 hours**.

QAX9... → OZW772...

- Web Server OZW772... reads the current consumption on the QAX9... **daily** between 5 and 10 am.
- Individual meter values are available immediately after reading.
- Reading is finished earlier accordingly on plants that do not fully use the maximum number of 512 meters.

Synco 700 → OZW772...

- The Synco 700 controller adds up the pulses every 5 minutes.
- Web Server reads the current values **daily** between 5 and 10 am.

S-Mode → OZW772...

- The KNX S-Mode values are transmitted by meters with COV to the OZW772...
- Current values, defined for a meter media, are taken over in the consumption data file **daily** between 5 and 10 am.

- OZW772... → Reading
- The user determines the read time for consumption data file via file transfer. With daily readings, the user can read the Web Server value up to 24 hours after the Web Server reading.
 - The consumption data file is sent by e-mail as soon as the consumption data is collected.
- Summary
- Via the chain (1) (3) (5) (6), the current values for WRI982 pulse meters are a maximum of 5 hours old plus read delay.
 - Via the chain (2) (3) (5) (6), the current values for M-bus meters are a maximum of 8 hours old plus read delay.
 - Via the chain (4) (5) (6), the current values for the pulse meters to Synco 700 controllers feature only the read delay.
- Current value time stamp
- The current value timestamp is written as follows to the consumption data file:
- For WRI982 pulse meters: Added up hourly by WRI982.
 - For M-bus meters **without** a manufacturer-specific timestamp: by QAX9..., at read time QAX9.../WRI982.
 - For M-bus meters with a manufacturer-specific timestamp: by the M-bus meter at the manufacturer-specific time.
 - For Synco 700 pulse inputs: By Synco 700 controller, added up every 5 minutes.

Monthly values

WRI982 → QAX9...

Monthly values are transmitted every 24 hours.

QAX9... → OZW772...

The monthly values are transmitted on the third day of the month between 5 am and 10 pm.

Note



Not all M-bus meters form their own monthly values. If not, the QAX9... assumes the task.

Synco 700 → OZW772...

The Synco 700 controller forms its own monthly value. The reading takes place on the third day of the month between 5 am and 10 pm.

S-Mode → OZW772...

The OZW772... does not have an S-Mode input for monthly values and therefore does not provide any. The entry in the consumption data file remains blank.

Due day

Due day formation

The due day values of meters connected to the QAX9... are formed on the centralized due day. The due day for QAX9... is active in the default state (Default setting of December 31), but can be edited on the QAX9... or via Web Server (see Section 2.5.3.6 "Consumption data").

Please note the following, however:

- A temporary due day value is formed during the commissioning of the QAX9...: This is the start value of the meter using the start value date.
- The first due day value is formed using the due day date if the centralized due day is reached for the first time.
- Due days that differ from the centralized due day (by the corresponding M-bus meters) are blocked accordingly.
- A due day value is used for precision only if one M-bus meters supplies a due day value on the centralized due day.

Time ratios

WRI982 → QAX9...

Due day values are transmitted every 4 hours.

QAX9... → OZW772...

The due day values are transmitted on the third day of the month between 5 am and 10 pm.

Please note the following for the Web Server at the conclusion of the comments under "Due day formation":

- The temporary due day value and its dates is written to the due day field for in the consumption data file if the QAX9... has not yet achieved a due day by the first transmission to the Web Server.
- At the latest then, the first real due day value with due date is available on the QAX9... 12 months after commissioning and is written at the start of the next month (third day) to the field due day of the consumption data file.

Notes



- A due day value is still available on the Web Server on the third day of the month if the due day is set to the first day of a month.
- Synco 700 controllers do not support the due day function.
- The OZW772... do not have an S-Mode input for due date.

Replace meter

A change to the configuration of the QAX9.../ Synco 700 controller causes a meter replacement. The information is provided to the Web Server accordingly.

Notes



- A new generation of the device web pages after a device exchange of QAX9... or Synco 700 controller always results in a meter replacement even when the same meter is re-connected to the replacement device.
- Hiding a device in the device list also results in a meter replacement.

QAX9...

Changes to the following information are interpreted as a meter replacement:

- Meter medium
- Meter ID number

The following changes are also evaluated for pulse meters:

- Unit factor (e.g. from "10 Wh" to "100 Wh")
- Pulse value (counter or denominator)
- Start value

Synco 700 controller

Changes to the following information are interpreted as a meter replacement:

- Unit
- Format (number of decimal places)

S-Mode meter

The following events are interpreted as meter changes:

- Change to data point type with ETS
- Change to meter media with ETS
- If the new value is less than the old value

Time ratios

The following time ratios apply to meter replacement:

- It last up to 8 hours from the time the meter (as defined above) is replaced until the information is available on a consistent basis on the QAX9...
- The following midnight (12:00 am) OZW772... **automatically** re-generates all devices where it has detected a meter replacement.
- You must also wait 8 hours after meter replacement when generated manually.
- The following information is available immediately for Synco 700 controllers.
- After writing S-Mode data points with ETS, the device web page for OZW772... must be generated or updated.
- The OZW772... detects the meter replacement during the daily reading between 5 and 10 am.

Web Server start value The Web Server maps the Web Server start value as soon as it receives the first meter value after generating the Synco device.

Notes  • The Web Server start value is not the same as the start value for the meter available on the QAX9...
• An initial generation also occurs when the Synco device is hidden and then shown after using generate. The reason for the exception is that hiding Synco devices with meters is backed up using meter replacement. Otherwise, meters relevant to allocations can unintentionally disappear from the consumption data file.

Exemption from liability The Siemens system for transmitting acquired consumption data for meters uses the latest technology and security standards. The value as displayed on the meter applies for allocation purposes in the event of differences between the displayed value on the meter and the value as transmitted.

6.3 Send consumption data file

Settings are available under: Home > 0.2.150 OZW772.xx > Settings > Consumption data > Receiver > E-mail receiver 1...2

To set, see Section 2.5.3.6 "Consumption data".

Information on the e-mail outline is available in section 8.2.

Information on outline and content of the appended consumption data file is available in Section 6.1.

7 "Energy indicator" function

7.1 Introduction

7.1.1 Function description

"Energy indicator" function

The OZW772... Web Server from Version 4.0 supports the "Energy indicator" function.

The Web Server uses the "Energy indicator" function to read selected data point values from the bus devices and to compare the values to energy-related limit values, or so-called "Green limits".

The data points are also monitored for adherence to the "Green limits". As a result, the "Energy indicator" is displayed in the form of a tree leaf.

Monitored data points and their "Green limits"

The monitored data points and their "Green limits" depend on the device type. The following applies e.g. to a controller:

Monitored data points	"Green limits" (technical energy limit values)
Comfort heating setpoint	>22 °C
Economy heating setpoint	>16 °C
Comfort cooling setpoint	<23 °C
Economy cooling setpoint	<34 °C
Readjustment room unit	>± 1.0 K (± readjustment has 2 "Green limits")
Preselection (operating modes)	Auto, Economy, Protection → "Green leaf" (continuous Comfort, Precomfort → "Orange leaf")

Notes

The "Green limits" are used only together with the "Energy indicator" function. They do **not** represent process or safety limit values which trigger e.g. fault messages or turn off the plant in the event of limit violations.

Users also are allowed to change data point values (setpoints). E-mail messages from the system then remind the user that a value or values were changed.

Tree leaf as "Energy indicator"

Green leaf 

"Green leaf" → Green tree leaf, leaf pointing up.

- The "Green leaf" symbol indicates that a data point value has not exceeded its "Green limit", i.e. the value is within a "green" range in terms of energy consumption.

Orange leaf 

"Orange leaf" → Orange tree leaf, leaf pointing down.

- The "Orange leaf" symbol indicates that a data point value has exceeded its "Green limit", i.e. the value is outside a "green" range in terms of energy consumption.

Grey leaf 

"Gray leaf" → Gray tree leaf, horizontal leaf.

- The "Grey leaf" symbol indicates that a data point value is not current, e.g. transmission of a data point value is incomplete, or there is no data communication with the bus.

No tree leaf

- The data point is not monitored via the "Energy indicator" function.

Standard EN 15232

The "Energy indicator" function is based on standard EN 15232 "Energy efficiency in buildings".

**Example: Web page
"Energy indicator"**

Web page with "Energy indicator" function; example with data points from "Room 1" and open dialog box to set data point value "Comfort heating setpoint" and its "Green limit" (for "Room 1").

The screenshot shows the Siemens OZW772.250 web interface. The top navigation bar includes 'Home | Energy indicator | Faults | File transfer | User accounts | Device web pages'. The main content area displays a table of energy indicator data points for 'Room 1'. An 'Edit' dialog box is open, allowing the user to adjust the 'Comfort heating setpoint' value to 21.0 and the 'Green limit(s)' to 22.0.

Energy indicator	Datapoint	Value	Green limit(s)
<input checked="" type="checkbox"/>	Preselection	Auto	Auto, Economy, Protection
<input checked="" type="checkbox"/>	Economy cooling setpoint	35.0 °C	34 °C
<input checked="" type="checkbox"/>	Precomfort cooling setpoint	28.0 °C	27 °C
<input checked="" type="checkbox"/>	Comfort cooling setpoint	24.0 °C	23 °C
<input checked="" type="checkbox"/>	Comfort heating setpoint	21.0 °C	22 °C
<input checked="" type="checkbox"/>	Precomfort heating setpoint	20.0 °C	21 °C
<input checked="" type="checkbox"/>	Economy heating setpoint	15.0 °C	16 °C
<input checked="" type="checkbox"/>	Readjustment room unit	0.0 K	1 K

7.1.2 KNX bus topology

The OZW772.01 Web Server can monitor 1 bus device via the "Energy indicator" function. The OZW772.04 Web Server can monitor up to 4, OZW772.16 up to 16, and OZW772.250 up to 250 bus devices via the "Energy indicator" function.

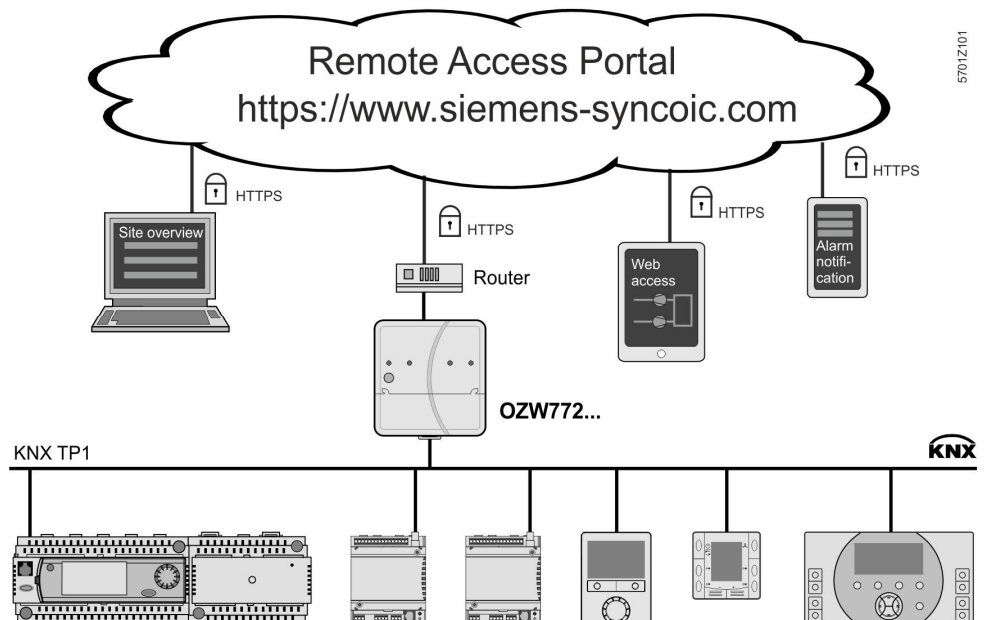

Note

A maximum processing time of ca. 8 hours results for a max. quantity of 2500 "Energy indicator" data points.

7.1.3 Synco product range

The following KNX devices from the Synco range can be connected to the OZW772... Web Server.

Synco range	Synco devices	Data sheet no.	
Synco 700	Universal controller	RMU7x0, RMU7x0B	N3144, N3150
	Heating controller	RMH760, RMH760B	N3131, N3133
	Boiler sequence controller	RMK770	N3132
	Central control unit	RMB795, RMB795B	N3121, N3122
	Switching & monitoring unit	RMS705, RMS705B	N3123, N3124
	Room unit	QAW740	N1633
Synco RXB/RXL	Room controller	RXB21.1, RXB22.1	N3873
	Room controller	RXL21.1, RXL22.1	N3877
	Room controller	RXB24.1	N3874
	Room controller	RXL24.1	N3878
	Room controller	RXB39.1/FC-13	N3875
	Room controller	RXL39.1/FC-13	N3876
Synco RDG/RDD/RDF/RDU	Room thermostat for fan coils	RDG100KN RDG160KN, RDG165KN	N3191
	Room thermostat for VAV	RDG400KN	N3192
	Room thermostat for fan coils	RDF301	N3171
	Room thermostat for fan coils and lighting	RDF301.50	N3171
	Room thermostat for fan-coil	RDF600KN	N3171
	Touchscreen thermostat for fan-coil	RDF800KN	N3174
	Touchscreen thermostat for fan-coil	RDD810KN/NF	N3175
	Room thermostat for VAV	RDU341	N3172
Synco living	Central apartment unit	QAX903	N2741
	Central apartment unit	QAX910	N2707
	Central apartment unit	QAX913	N2740

Important note The "Energy indicator" function is supported in all Synco devices (see table above) excepting:

Synco 700: RMU7x0, RMH760, RMK770 V1, RMS705

Synco living: QAX910 V1 und V2

Device description If the "Device description" of a device contains "Energy indicator" data points and "Green limits", the device can be operated on the "Energy indicator" function. "Energy indicator" data points and "Green limits" have predefined, device-specific default values. The default values can be changed with a few notable exceptions. Neither number nor selection of the "Energy indicator" data points and "Green limits" that exist in the "Device description" can be changed.

7.1.4 Navigation and device web pages

Navigation

Go to the "Energy indicator" function as follows:

- Via primary navigation, main function "Energy indicator".
- Click the "Plant state Energy indicator" pane (top right field pane tree leaf in the screenshot below).

Primary navigation

On the web page, you can select the "Energy indicator" function from the primary navigation next to "Home".

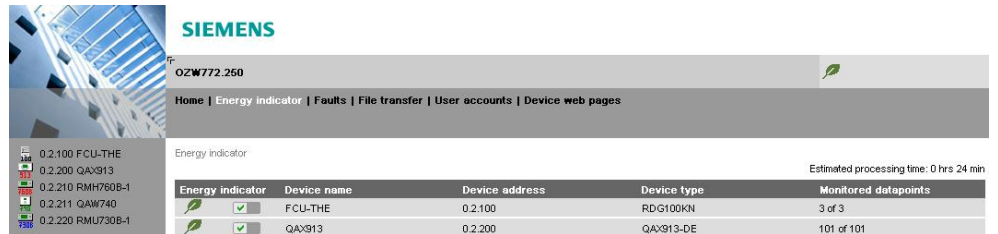

Energy indicator	Device name	Device address	Device type	Monitored datapoints
<input checked="" type="checkbox"/>	FCU-THE	0.2.100	RDG100KN	3 of 3
<input checked="" type="checkbox"/>	QAX913	0.2.200	QAX913-DE	101 of 101

Secondary navigation

In secondary navigation, both partial plants and/or devices are displayed sorted by device address in ascending order.

Device web pages status "Generated"

Status "Generated" in column "Status" in "Device web pages" is a precondition for displaying the devices using the "Energy indicator" function (see Section 2.4).

Path: Home > ... > Device web pages

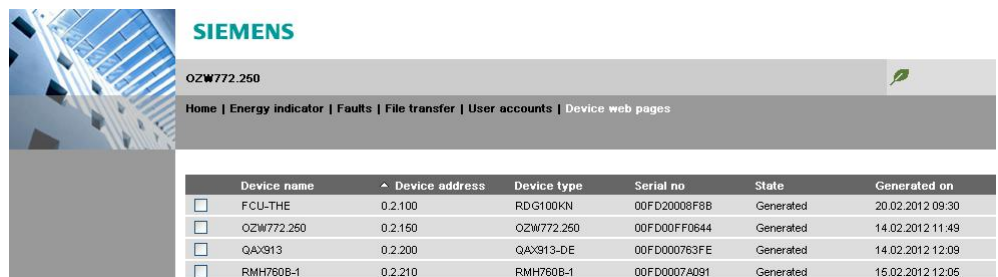

Device name	Device address	Device type	Serial no	State	Generated on
<input type="checkbox"/> FCU-THE	0.2.100	RDG100KN	00FD20008F88	Generated	20.02.2012 09:30
<input type="checkbox"/> OZW772.250	0.2.150	OZW772.250	00FD00FF0644	Generated	14.02.2012 11:49
<input type="checkbox"/> QAX913	0.2.200	QAX913-DE	00FD000763FE	Generated	14.02.2012 12:09
<input type="checkbox"/> RMH760B-1	0.2.210	RMH760B-1	00FD0007A091	Generated	15.02.2012 12:05

Note

The "Device web pages" (see screenshot) pane can be opened with "Service" and "Administrator" access rights.

7.2 "Energy indicator" function levels

Level designations

The contents of the "Energy indicator" function are distributed across 2 or 3 levels depending on the functionality of the respective device.

- Simple devices have 2 levels:
 - "Plant"
 - "Data points"
- Complex devices have 3 levels:
 - "Plant"
 - "Partial plants"
 - "Data points"

7.2.1 "Plant" level

Enter the "Plant" level

Enter the "Plant" level as follows:

- Click the "Energy indicator" function (primary navigation) or
- Click the "Plant state Energy indicator" pane.

The "Plant" level shows all devices of a plant subject to the "Energy indicator" function.

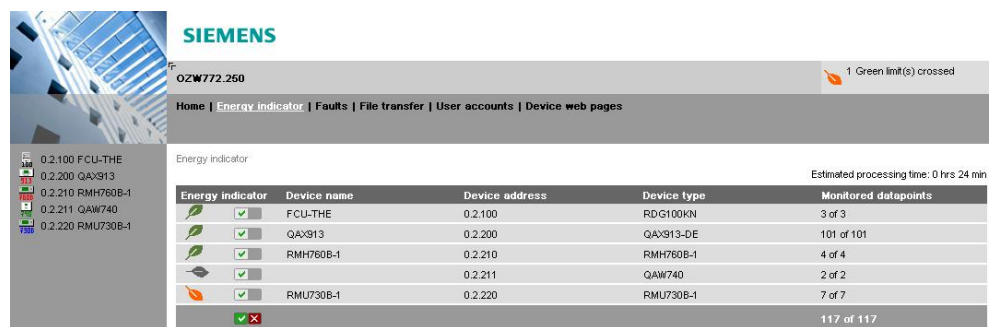

The screenshot shows the Siemens Energy indicator web interface. At the top, there is a Siemens logo and a navigation bar with links for Home, Energy indicator, Faults, File transfer, User accounts, and Device web pages. Below the navigation bar, there is a table titled "Energy indicator" with the following columns: Energy indicator, Device name, Device address, Device type, and Monitored datapoints. The table contains five rows of data, each representing a device. The first row is for FCU-THE, the second for QAX913, the third for RMH760B-1, the fourth for QAW740, and the fifth for RMU730B-1. Each row has a green leaf icon in the "Energy indicator" column and a checkbox in the "Device name" column. The "Monitored datapoints" column shows the number of monitored datapoints for each device. At the bottom right of the table, there is a summary row showing "117 of 117".

Energy indicator	Device name	Device address	Device type	Monitored datapoints
	FCU-THE	0.2.100	RDG100KN	3 of 3
	QAX913	0.2.200	QAX913-DE	101 of 101
	RMH760B-1	0.2.210	RMH760B-1	4 of 4
	QAW740	0.2.211	QAW740	2 of 2
	RMU730B-1	0.2.220	RMU730B-1	7 of 7
				117 of 117

"Energy indicator" for a plant

The "Energy indicator" of the plant is displayed as a **summary display** in the "Plant state Energy indicator" pane. See Section 7.2.6 for information on the summary display.

"Energy indicator" for devices

The "Energy indicator" for devices is displayed at the "Plant" level in the "Energy indicator" column for each device.

Next lower level

Clicking the name of a device in secondary navigation or in the "Device name" column opens the next lower level for that device.

Table columns

Energy indicator

"Energy indicator" (tree leaf) for each actively monitored device.

This column also contains:

- Checkboxes to activate/deactivate monitoring of the "Energy indicator" data points for the selected device.
- Summary checkbox (green/red) to activate/deactivate monitoring for all data points of the plant.

The summary checkbox is available only for access level "Administrator"; see Section 7.3.4.

When a checkbox is cleared (deactivated), message "Monitoring off, green limits reset to default values! Really to be continued?" is displayed; see Section 7.3.4.

Device name, device type	The device name is displayed if defined (prior to creating the "Device list"), otherwise the device type. The devices are sorted by device address in ascending order.
Device address	Network address (area.line.device address)
Device type	Device type (technical device designation)
Monitored data points	Indication of the number of actively monitored data points (x) for possible number of data points to be monitored (y) for each device; see Section 7.2.4.
Note	Clicking the column title <ul style="list-style-type: none"> • Device name • Device address • Device type sorts the column contents in the table in ascending or descending order.

7.2.2 "Partial plants" level

"Partial plants" level

The "Partial plants" level shows the partial plants of functionally complex devices (see partial plants below for QAX913 central apartment unit).

Energy indicator	Partial plant name	Monitored datapoints
	Apartment operating mode	1 of 1
	Room 1	8 of 8
	Room 2	8 of 8
	Room 3	8 of 8
	Room 4	8 of 8
	Room 5	8 of 8
	Room 6	8 of 8
	Room 7	8 of 8
	Room 8	8 of 8
	Room 9	8 of 8
	Room 10	8 of 8
	Room 11	8 of 8
	Room 12	8 of 8
	DHW	4 of 4

Next lower level Clicking the name of a partial plant in secondary navigation or in the "Partial plant name" column opens the next lower level for that partial plant.

Next higher level Clicking Upward (in secondary navigation) opens the next higher level.

Table columns

Energy indicator "Energy indicator" (tree leaf) for each actively monitored partial plant.
This column also contains the checkboxes to activate/deactivate "Energy indicator" monitoring of the data points for the selected partial plant (deactivate without confirmation message).

Partial plant name Name of the partial plant (taken over by device).

Monitored data points Indication of the number of **actively** monitored data points (x) for possible number
of data points to be monitored (y) for each partial plant; see Section 7.2.4.

Notes

When level "Partial plants" is selected, they are sorted by "Device description". Users cannot change the sort order.

In functionally complex devices with many data points, they are assigned to the partial plants. The data points of the partial plants (per partial plant) are displayed at the "Data point" level; see below.

The "Partial plants" level is not available in functionally simple devices with few data points.

7.2.3 "Data points" level

"Data points" level

The "Data points" level shows the data points to be monitored (see the data points for partial plant "Room 1" below).

Energy indicator	Data point	Value	Green limit(s)
	<input checked="" type="checkbox"/> Preselection	Auto	Auto, Economy, Protection
	<input checked="" type="checkbox"/> Economy cooling setpoint	35.0 °C	34 °C
	<input checked="" type="checkbox"/> Precomfort cooling setpoint	28.0 °C	27 °C
	<input checked="" type="checkbox"/> Comfort cooling setpoint	24.0 °C	23 °C
	<input checked="" type="checkbox"/> Comfort heating setpoint	21.0 °C	22 °C
	<input checked="" type="checkbox"/> Precomfort heating setpoint	20.0 °C	21 °C
	<input checked="" type="checkbox"/> Economy heating setpoint	15.0 °C	16 °C
	<input checked="" type="checkbox"/> Readjustment room unit	0.0 K	1 K

Next higher level

Clicking Upward (in secondary navigation) opens the next higher level.

Table columns

Energy indicator

"Energy indicator" (tree leaf) for each actively monitored data point.

This column also contains the checkboxes to activate/deactivate "Energy indicator" monitoring of the selected data point (deactivate without confirmation message).

Data point

Name of the data point.

Value

Value of the data point (dependent on data point type with unit, e.g. °C).

Symbol (red pen)

Clicking the red pen symbol opens the dialog box for the selected data point; see Section 7.4.

Green limit(s)

Value of the set "Green limit" (dependent on data point type and unit).

Enumeration values for "Green leaf" are displayed for "Green limits" with enumeration values such as Auto, Comfort, Economy.

Invisible values are replaced by dots "..." if not all enumeration values can be displayed. The dialog box (click red pen symbol) shows all enumeration values.

Note

When level "Data points" is selected, they are sorted by "Device Description". Users cannot change the sort order.







7.2.4 Number of "Monitored data points"

Column "Monitored data points"

The "Monitored data points" column shows the number of **actively** monitored data points (x) compared to the number of data points (y) that could be monitored.















"Plant" level

"x of y" is displayed for each device and partial plant in the corresponding row. The sum of all devices and partial plants is displayed in the bottom row.

Energy indicator	Device name	Device address	Device type	Monitored datapoints
 <input checked="" type="checkbox"/>	FCU-THE	0.2.100	RD/G100KN	2 of 3
 <input checked="" type="checkbox"/>	QAX913	0.2.200	QAX913-DE	93 of 101
 <input checked="" type="checkbox"/>	RMH760B-1	0.2.210	RMH760B-1	4 of 4
 <input checked="" type="checkbox"/>		0.2.211	QAW740	1 of 2
 <input checked="" type="checkbox"/>	RMU730B-1	0.2.220	RMU730B-1	7 of 7
 <input checked="" type="checkbox"/>				107 of 117

"Partial plants" level

"x of y" is displayed for each partial plant in the corresponding row and the sum of all partial plants is displayed in the bottom row.

Energy indicator	Partial plant name	Monitored datapoints
 <input checked="" type="checkbox"/>	Apartment operating mode	1 of 1
 <input checked="" type="checkbox"/>	Room 1	8 of 8
 <input checked="" type="checkbox"/>	Room 2	0 of 8
 <input checked="" type="checkbox"/>	Room 3	8 of 8
 <input checked="" type="checkbox"/>	Room 4	8 of 8
 <input checked="" type="checkbox"/>	Room 5	8 of 8
 <input checked="" type="checkbox"/>	Room 6	8 of 8
 <input checked="" type="checkbox"/>	Room 7	8 of 8
 <input checked="" type="checkbox"/>	Room 8	8 of 8
 <input checked="" type="checkbox"/>	Room 9	8 of 8
 <input checked="" type="checkbox"/>	Room 10	8 of 8
 <input checked="" type="checkbox"/>	Room 11	8 of 8
 <input checked="" type="checkbox"/>	Room 12	8 of 8
 <input checked="" type="checkbox"/>	DHW	4 of 4
		93 of 101

Note

Level "Data points" does not have indication "x of y".

7.2.5 "Energy indicator" visibility

Configuration of visibility

Visibility of the "Energy indicator" symbol is configured at the "Administrator" access level and "Service" in the Web Server.

Path: OZW772.xx > Settings > Energy indicator > Energy indicator on the web (very bottom of web page)

The screenshot shows the configuration page for the 'Energy indicator' in a web server. The page has a breadcrumb trail: Home > Energy indicator > Faults > File transfer > User accounts > Device web pages. A left sidebar contains a menu with items like 'Web server', 'Time of day/date', 'Communication', 'Message receiver', 'System report', 'Consumption data', 'Energy indicator', 'Faults', and 'Texts'. The main content area is a table with columns 'Datapoint' and 'Value'. The table lists various settings for 'E-mail receiver 1' and 'E-mail receiver 2', including 'E-mail address', 'Transmit time 1', 'Release transmit time 1', 'Transmit time 2', 'Release transmit time 2', 'Test receiver', 'Energy indicator sent', and 'Cause'. An 'Edit' dialog box is overlaid on the table, titled 'Edit', with a sub-header 'Energy indicator on the web'. It contains two radio buttons: 'Not visible' (unselected) and 'Visible' (selected). 'OK' and 'Cancel' buttons are at the bottom of the dialog.

Datapoint	Value
E-mail receiver 1	
E-mail address	mailrecipient@example.com
Transmit time 1	00:00 h.m
Release transmit time 1	Off
Transmit time 2	00:00 h.m
Release transmit time 2	Off
Test receiver	—
Energy indicator sent	—
Cause	—
E-mail receiver 2	
E-mail address	mailrecipient@example.com
Transmit time 1	00:00 h.m
Release transmit time 1	Off
Transmit time 2	00:00 h.m
Release transmit time 2	Off
Test receiver	—
Energy indicator sent	—
Cause	—
Visibility	—
Energy indicator on the web	Visible

Notes

"Energy indicator" remains active even if "Energy indicator on the web = Not visible" is selected.

Configuration "Energy indicator on the web" (Visible/Not visible) also applies to user groups "Service" and "End user".

7.2.6 Summary display "Energy indicator" for a plant

Summary display

The "Energy indicator" of the plant OR-links the "Energy indicators" of all devices across all levels. It is displayed as a summary:

- LED ① on the Web Server (see figure in Section 1.2).
- Web page "Plant" in the "Plant state Energy indicator" pane.

LED ① on Web Server

The following colors of LED ① on the Web Server front mean:

- LED is lit green "Energy indicator" of the plant = "Green leaf".
- LED is lit orange "Energy indicator" of the plant = "Orange leaf".

Summary display "Plant" web page



- "Green leaf"
All actively monitored data points of the plant are within limits, i.e. no "Green limits" are violated.
- "Orange leaf"
At least one monitored data point is outside its "Green limit".
The number of data points outside their "Green limit" is displayed in addition to the tree leaf.

The summary display "Orange leaf" with "2 Green limit(s) crossed" is displayed (in the previous example) because two "Green limits" were exceeded in "Controller 1" (see next screenshot).

Energy indicator	Datapoint	Value	Green limit(s)
	<input checked="" type="checkbox"/> Economy cooling setpoint	33.9 °C	34 °C
	<input checked="" type="checkbox"/> Precomfort cooling setpoint	28.0 °C	27 °C
	<input checked="" type="checkbox"/> Comfort cooling setpoint	24.0 °C	23 °C
	<input checked="" type="checkbox"/> Comfort heating setpoint	21.0 °C	22 °C
	<input checked="" type="checkbox"/> Precomfort heating setpoint	19.0 °C	21 °C
	<input checked="" type="checkbox"/> Economy heating setpoint	16.1 °C	16 °C

7.3 "Energy indicator" commissioning function

7.3.1 Commissioning notes

Prerequisites

Prerequisites for commissioning the "Energy indicator" function:

- Login with "Administrator" access right.
- Generating the devices in the Web Server. This generates the "Energy indicator" data points for each device.
- Devices on the Device web pages must have status "Generated".

Device web pages

Home | Energy indicator | Faults | File transfer | User accounts | Device web pages

Device name	Device address	Device type	Serial no	State	Generated on
<input type="checkbox"/> OZW772.250	0.2.150	OZW772.250	00FD00FF0644	Generated	23.02.2012 10:59
<input type="checkbox"/> QAX913	0.2.200	QAX913-DE	00FD000763FE	Generated	23.02.2012 11:56
<input type="checkbox"/> RMH760B-1	0.2.210	RMH760B-1	00FD0007A091	Generated	23.02.2012 12:00
<input type="checkbox"/>	0.2.211	QAW740	00FD00076B24	Generated	23.02.2012 12:04
<input type="checkbox"/> RMU730B-1	0.2.220	RMU730B-1	00FD0007980B	Generated	23.02.2012 12:08
<input type="checkbox"/> Device 230	0.2.230	RMU730-1	00FD00001DF7	Generated	23.02.2012 12:09

Add Delete Generate Hide

7.3.2 Start "Energy indicator" function

Start "Energy indicator" function

The "Energy indicator" function in the OZW772... Web Server is started automatically if the above prerequisites are fulfilled.



Notes

The devices must contain at least one "Energy indicator" data point to be displayed as part of the "Energy indicator" function.

The "Energy indicator" database only exists on the Web Server. And the Web Server itself has no data points subject to the "Energy indicator" function.

Temporary status

"---" is temporarily displayed for a data point's status in the "Value" column until the data point value is read and processed via the bus.

Energy indicator	Datapoint	Value	Green limit(s)
	<input checked="" type="checkbox"/> Preselection	Auto	Auto, Economy, Protection
	<input checked="" type="checkbox"/> Economy cooling setpoint	34.0 °C	34 °C
	<input checked="" type="checkbox"/> Precomfort cooling setpoint	28.0 °C	27 °C
	Comfort cooling setpoint	---	---
	Comfort heating setpoint	---	---
	Precomfort heating setpoint	---	---
	Economy heating setpoint	---	---
	Readjustment room unit	---	---

Updates on the web page

A maximum of 4 "Energy indicators" per second are updated on a web page. The actual number depends on effective bus load. In the event of concurrent user access, bandwidth is distributed across all users.

Note

Device data point values are not transmitted if there is no bus supply or if the KNX bus is interrupted.

No comparison to "Green limits" then takes place and column "Value" contains "---" while column "Energy indicator" displays a "Grey leaf".

7.3.3 Estimated processing time

After starting the "Energy indicator" function, the "Plant" web page contains the following:







- Summary display "Energy indicator"; see Section 7.2.6.
- Number of monitored data points; see Section 7.2.4.
- "Estimated processing time"; see below.

Estimated processing time

The "Estimated processing time" is displayed in hours and minutes.

Energy indicator

Estimated processing time: 0 hrs 24 min

Energy indicator	Device name	Device address	Device type	Monitored datapoints
 <input checked="" type="checkbox"/>	FCU-THE	0.2.100	RDIG100KN	3 of 3
 <input checked="" type="checkbox"/>	QAX913	0.2.200	QAX913-DE	101 of 101
 <input checked="" type="checkbox"/>	RMH760B-1	0.2.210	RMH760B-1	4 of 4
 <input checked="" type="checkbox"/>		0.2.211	QAW740	1 of 2
 <input checked="" type="checkbox"/>	RMU730B-1	0.2.220	RMU730B-1	7 of 7
 <input checked="" type="checkbox"/>				116 of 117

Processing time at base load

When monitoring is active, the Web Server first reads each data point from the bus devices and then compares the values to its "Green limit".

Processing time at base load per data point is 12 seconds (longer if the bus carries a heavy load).

Updated display for "Energy indicator"

The Web Server can process up to 2500 "Energy indicator" data points. Thus, updating the "Energy indicator" (leaf color) display may take hours. Therefore:

- "Green leaf" (start-up mode)
The "Green leaf" display does not necessarily reflect the current plant state prior to completion of the "Estimated processing time".
- The updated display of "Energy indicator" can be postponed by max. the "Estimated processing time".

Note

Note the restriction from the "updated "Energy indicator" display" also when navigating to other web pages.

7.3.4 Deactivating "Data point monitoring"

Deactivation

Monitoring "Energy indicator" data points is activated automatically following device list creation.

Thus, data point monitoring can only be deactivated as a first step.

Deactivation for "Data point monitoring" requires "Administrator" access rights.

The checkbox in the "Energy indicator" column allows for deactivating monitoring of one or multiple data points e.g. for operational reasons.



Data point monitoring active (default following commissioning)



Data point monitoring deactivated

"Plant" level
 Selecting the checkbox deactivates the data points for the selected device (can be reactivated).
 Selecting the summary checkbox (green/red, bottom row) deactivates the data points for the plant (can be reactivated)).

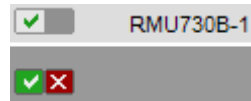

Note
 A **confirmation message** is displayed when data point monitoring for a device or plant is deactivated; see below.

"Partial plants" level
 Selecting the checkbox deactivates the data points for the selected partial plant (can be reactivated)).
No confirmation message is displayed when data point monitoring for a partial plant is deactivated.

"Data points" level
 Selecting the checkbox deactivates the selected data point (can be reactivated)).
No confirmation message is displayed prior to deactivating monitoring.

Confirmation message for "Monitoring off"
 A confirmation message is displayed when data point monitoring for a device or plant is deactivated:

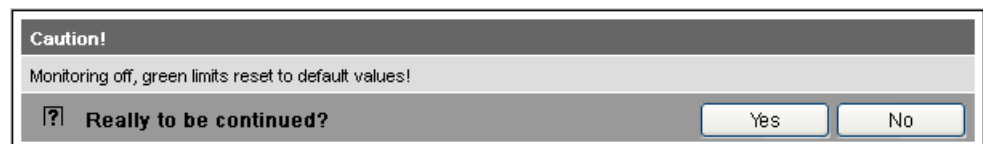

Green limits to default values!
 Clicking [Yes] for message "Really to be continued?" to deactivate monitoring also resets "Green limits" (changed by the user) to their default values. Therefore:
 "Monitoring off" deactivates monitoring while, at the same time, setting the "Green limits" to the default values of device list creation.

Note
 Contrary to the "Green limits", deactivation does **not** reset changed data point values to default values. Therefore:
 Following "Monitoring off" and reactivation, "Energy indicator" data points may no longer be within the green limits, as the "Green limits" reset to default values have different dependencies.

7.3.5 Activating "Data point monitoring"

Activation

Monitoring "Energy indicator" data points is activated automatically following device list creation.

Data point monitoring can thus be activated only following deactivation; see Section 7.3.4.

Activation for "Data point monitoring" requires "Administrator" access rights. The checkbox in the "Energy indicator" column allows for activating monitoring of one or multiple data points e.g. following temporary deactivation.



Data point monitoring deactivated (by user)



Data point monitoring activated

"Plant" level

Selecting the checkbox activates the data points for the selected device.

Selecting the summary checkbox (green/red, bottom row) activates the data points for the plant.

"Partial plants" level

Selecting the checkbox activates the data points for the selected partial plant.

Example

Monitoring is deactivated for partial plant "Room 2". As a result, all data points are deactivated.

Partial plant "Room 2" is deactivated.

Energy indicator	Partial plant name
<input checked="" type="checkbox"/>	Apartment operating mode
<input checked="" type="checkbox"/>	Room 1
<input type="checkbox"/>	Room 2

"Monitored data points" 0 of 8.

Monitored datapoints
1 of 1
8 of 8
0 of 8

Data points "Room 2" are deactivated.

Energy indicator	Datapoint
<input type="checkbox"/>	Preselection
<input type="checkbox"/>	Economy cooling setpoint
<input type="checkbox"/>	Precomfort cooling setpoint
<input type="checkbox"/>	Comfort cooling setpoint
<input type="checkbox"/>	Comfort heating setpoint
<input type="checkbox"/>	Precomfort heating setpoint
<input type="checkbox"/>	Economy heating setpoint
<input type="checkbox"/>	Readjustment room unit

Selecting the checkbox for partial plant "Room 2" activates it. As a result, all data points at the "Data points" level are also activated.

Partial plant "Room 2" is reactivated.

Energy indicator	Partial plant name
<input checked="" type="checkbox"/>	Apartment operating mode
<input checked="" type="checkbox"/>	Room 1
<input checked="" type="checkbox"/>	Room 2

All data points of "Room 2" are reactivated.

Energy indicator	Datapoint
<input checked="" type="checkbox"/>	Preselection
<input checked="" type="checkbox"/>	Economy cooling setpoint
<input checked="" type="checkbox"/>	Precomfort cooling setpoint
<input checked="" type="checkbox"/>	Comfort cooling setpoint
<input checked="" type="checkbox"/>	Comfort heating setpoint
<input checked="" type="checkbox"/>	Precomfort heating setpoint
<input checked="" type="checkbox"/>	Economy heating setpoint
<input checked="" type="checkbox"/>	Readjustment room unit

"Data points" level

Selecting the checkbox activates the selected data point.

Example

Starting point: All data points of partial plant "Room 2" are deactivated.
Activating just one data point (of partial plant "Room 2") also activates the partial plant.

A data point of partial plant "Room 2" is activated.

Energy indicator	Datapoint
<input type="checkbox"/>	Preselection
<input type="checkbox"/>	Economy cooling setpoint
<input checked="" type="checkbox"/>	Precomfort cooling setpoint
<input type="checkbox"/>	Comfort cooling setpoint
<input type="checkbox"/>	Comfort heating setpoint
<input type="checkbox"/>	Precomfort heating setpoint
<input type="checkbox"/>	Economy heating setpoint
<input type="checkbox"/>	Readjustment room unit

Partial plant "Room 2" is automatically activated.

Energy indicator	Partial plant name
<input checked="" type="checkbox"/>	Apartment operating mode
<input checked="" type="checkbox"/>	Room 1
<input checked="" type="checkbox"/>	Room 2
<input checked="" type="checkbox"/>	Room 3
<input checked="" type="checkbox"/>	Room 4
<input checked="" type="checkbox"/>	Room 5
<input checked="" type="checkbox"/>	Room 6
<input checked="" type="checkbox"/>	Room 7

Note

Note that "Monitoring activated" at the "Partial plants" level does not mean that **all** subordinate data points are activated and monitored also. This also applies to "Monitoring activated" at the "Plant level".

7.4 Dialog boxes, data points, and "Green limits"

7.4.1 General dialog boxes

Open a dialog box

Clicking the red pen  symbol opens the dialog box for the selected data point. This allows you to either change the data point value and/or the "Green limit".



Example: Dialog box
Comfort heating setpoint

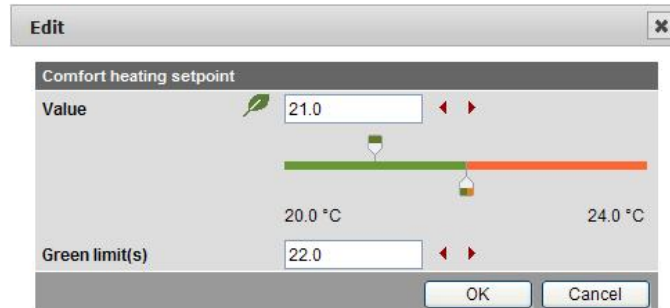

Contents

The dialog box contains the following information (example: Comfort heating setpoint):

- Name (data point) Comfort heating setpoint
- Value (data point) 21.0
- "Energy indicator" as:
 - "Green leaf" Green tree leaf
 - "Orange leaf" Orange tree leaf
- "Green limit(s)" 22.0
- Setting range 20.0 °C to 24.0 °C for data point and "Green limit(s)"

Value

Data point value

The set data point value is displayed in the field above the setting range. There are 3 ways to change the data point value:

- Change the data point value in the entry field.
- Move the data point slider to the right or left.
- Arrows ◀ ▶ to adjust the value step by step.

The data point slider is green for as long as the data point value is within the green setting range (up to and including "Green limit"). If the data point value is moved to the orange range, the slider turns orange.

Setting range

Bars

The setting range for the data point value and its "Green limit" corresponds to the green/orange bar limited by value indications to the right and left of the bar.

Green limit(s)

Each data point monitored with the "Energy indicator" function has its own "Green limit". There are 3 ways to change the "Green limit":

- Change the value for the "Green limit(s)" in the entry field.
- Move the "Green limit(s)" slider to the right or left.
- Arrows ◀ ▶ to adjust the value step by step.

The "Green limit" slider is always "green/orange". If the slider is moved to the setting range limit value, the bar color disappears in the direction of the movement.

Notes

The default values defined for data point and "Green limit(s)" in the "Device description" are displayed in the corresponding entry field.

After values are changed (by the user), default values can be regenerated only by deactivating "Data point monitoring" (with summary checkbox).

7.4.2 Dialog boxes with numeric data points

In numeric data points such as Comfort heating setpoint and Comfort cooling setpoint, the "Green limits" may depend on neighboring values. Therefore:

To achieve the desired setting range, the data points (heating and cooling setpoints) and their "Green limits" must be set in relation to the neighboring value.

Note

Dependency of neighboring values always depends on the data point values (setpoints), not the "Green limits".

Comfort heating setpoint

Comfort heating setpoint

Value  21.0

19.0 °C 24.0 °C

Green limit(s) 22.0

OK Cancel

Note

Set the heating setpoint by 1 K lower (or max. the same) as the "Green limit" to display the "Energy indicator" = "Green leaf".

Comfort cooling setpoint

Comfort cooling setpoint

Value  24.0

21.0 °C 28.0 °C

Green limit(s) 23.0

OK Cancel

Note

Set the cooling setpoint by 1 K higher (or max. the same) as the "Green limit" to display the "Energy indicator" = "Green leaf".

Readjustment room unit

In the "Readjustment room unit" dialog box, the adjustable data point value corresponds to the adjustment range, symmetrical to the zero-point axis. This requires 2 "Green limits".

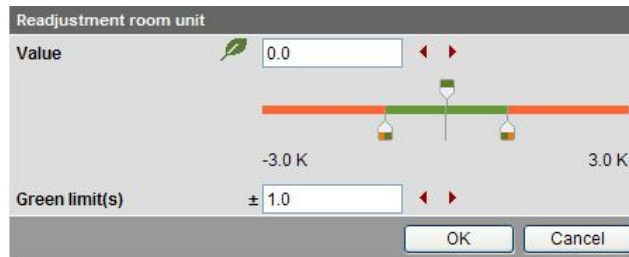

7.4.3 Dialog boxes with enumeration data points

A dialog box with enumeration values, at least one "Green limit" for a value to be monitored needs to be set.

Preselection operating mode

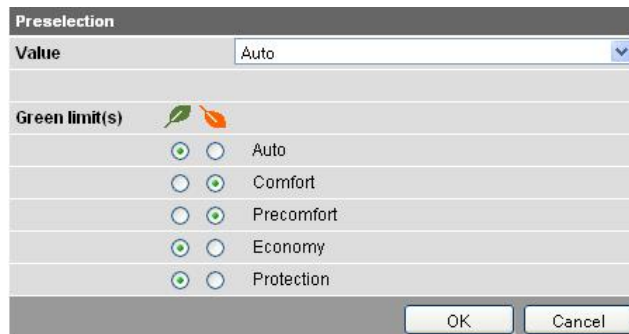

Note

The enumeration values are predefined as per the data point type. The "Green limit(s)" are set by clicking the selection boxes.

7.4.4 Dialog boxes with variable unit data points

Synco 700 universal devices can be used either to control temperature, humidity, or other physical variables. The setpoint is thus set with the corresponding variable, e.g. in [°C], [% r.h.] or [Pa] .

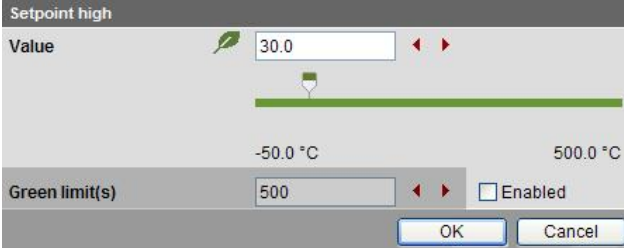

The screenshot shows a dialog box titled "Setpoint high". It contains a "Value" field with a green leaf icon and a numeric input set to 30.0, with left and right arrow buttons. Below this is a green horizontal slider bar with a white handle, spanning from -50.0 °C to 500.0 °C. At the bottom, there is a "Green limit(s)" field with a numeric input set to 500, left and right arrow buttons, and a disabled checkbox labeled "Enabled". "OK" and "Cancel" buttons are at the bottom right.

Dialog boxes with variable unit data points contain a disabled checkbox to set the "Green limit". The entry field and the arrows are grayed and the "Green limit" slider is hidden. The entire setting range bar is green.

The checkbox can be enabled with "Administrator" access rights. The "Green limit" can be set and the "Value" (data point value) is compared to the "Green limit".

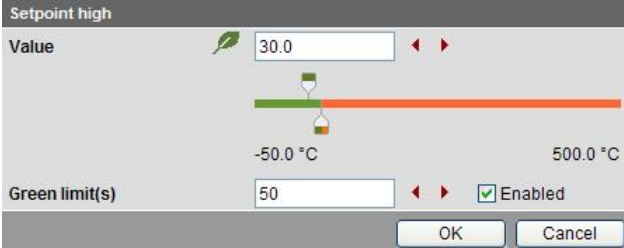

The screenshot shows the same "Setpoint high" dialog box, but with the "Green limit(s)" field set to 50 and the "Enabled" checkbox checked. The slider bar is now orange, and the "Value" field (30.0) is positioned above the slider, indicating it is within the active range.

7.4.5 Dialog boxes for data points with manually set value

The device presets the value during normal operation. You can manually set the value as an exception.



Dialog boxes for data points with a manually set value contain a checkbox. The value cannot be entered manually if the checkbox is cleared . The entry field and the arrows ◀ ▶ are grayed and the "Value" slider is hidden.

The value can be set if the checkbox is selected . The value is then also compared to the "Green limit".

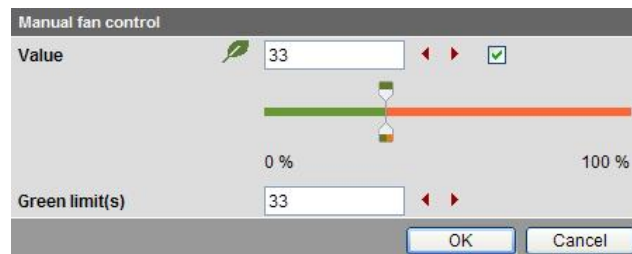

7.4.6 User groups "Service" and "End user"

The dialog boxes for the "Energy indicator" data points can be opened also in the "Service" and "End user" user groups.

However, contrary to the "Administrator" user groups, only data point values can be set, not "Green limits".

The entry fields for the "Green limits" are grayed, i.e. they are unavailable for editing. Other than that, the dialog boxes are the same as for the "Administrator" user group.

Comfort heating setpoint

Comfort heating setpoint

Value

Green limit(s)

20.0 °C 24.0 °C

OK Cancel

Readjustment room unit

Readjustment room unit

Value

Green limit(s)

-3.0 K 3.0 K

OK Cancel

Preselection operating mode

Contrary to the "Administrator" user group, the dialog box "Preselection" contains grayed enumeration values (operating modes).

User groups "Service" and "End user" thus can only read, but not change the set "Green limits".

Preselection

Value

Green limit(s)

Auto
Comfort
Precomfort
Economy
Protection

OK Cancel

7.5 E-mail with "Energy indicator" for the plant

7.5.1 E-mail receiver configuration

Either **no** E-mail (no transmit time = Default) or one or two e-mails (Transmit time 1 and/or Transmit time 2) can be sent with the plant's "Energy indicator".

E-mail receiver configuration

E-mail receivers 1 and 2 can be configured with "Administrator" and "Service" access rights on the Web Server.

Path: OZW772.xx > Settings > Energy indicator

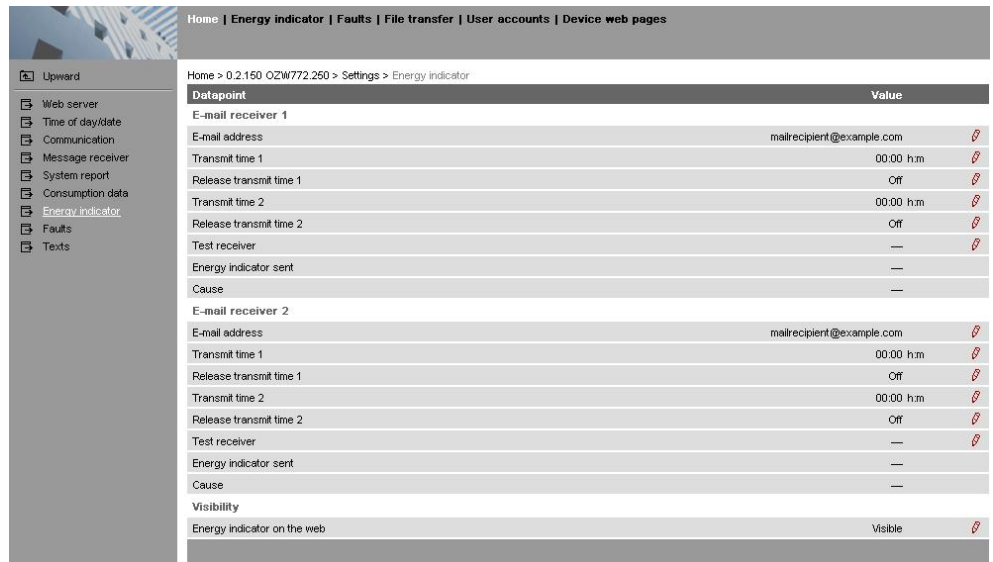

The screenshot shows a web interface for configuring email receivers. The breadcrumb path is 'Home > 0.2.150 OZW772.260 > Settings > Energy indicator'. The interface is divided into a left sidebar with navigation options and a main content area with a table of settings.

Datapoint	Value
E-mail receiver 1	
E-mail address	mailrecipient@example.com
Transmit time 1	00:00 h:m
Release transmit time 1	Off
Transmit time 2	00:00 h:m
Release transmit time 2	Off
Test receiver	—
Energy indicator sent	—
Cause	—
E-mail receiver 2	
E-mail address	mailrecipient@example.com
Transmit time 1	00:00 h:m
Release transmit time 1	Off
Transmit time 2	00:00 h:m
Release transmit time 2	Off
Test receiver	—
Energy indicator sent	—
Cause	—
Visibility	
Energy indicator on the web	Visible

Notes

E-mail receivers 1 and 2 are configured individually (separate settings).

If Transmit time 1 and/or 2 are configured, the "Energy indicator" of the plant is sent as an e-mail **only** if at least one monitored data point exceeds its "Green limit".

Configuration of e-mail receivers 1 and 2 for the "Energy indicator" of the plant is not related to the e-mail receivers of fault messages (device failure etc.) and ECA (Energy Cost Allocation).

Test receiver

One e-mail each can be sent for test purposes to E-mail receiver 1 and 2.

- The test is triggered manually via data point "Test receiver = Trigger".
- Reception is confirmed in data point "Energy indicator transmitted = Yes".
- Data point "Reason" contains feedback on whether the e-mail was sent or which setting must be checked in the event of an error.

"Energy indicator transmitted" and "Reason"

The values of the data points "Energy indicator transmitted" and "Reason" are displayed after testing until:

- Another test is triggered manually.
- The next transmitted e-mail is transmitted as per Transmit time 1 and/or 2.
- The device supply is switched on and off.

Data point	Function
Test receiver	[---, trigger]
"Energy indicator transmitted"	[---, Yes, No]
Reason	[---, DNS setting, mail server address, mail server port number, e-mail address Receiver, mail server authentication, network cable]

Note

Manual triggering for test purposes does not trigger a fault message.

Fault message e-mail

If an e-mail with "Energy indicator" of the plant is not transmitted without error, a fault message is triggered for the corresponding e-mail Receiver.

Reset fault message

The fault message is reset if:

- The next transmitted e-mail is transmitted as per Transmit time 1 and/or 2.
- Manually triggered "Test receiver" is successful.

Note

The diagnostic options are identical to those of other e-mail Receivers.

7.5.2 Mail inbox

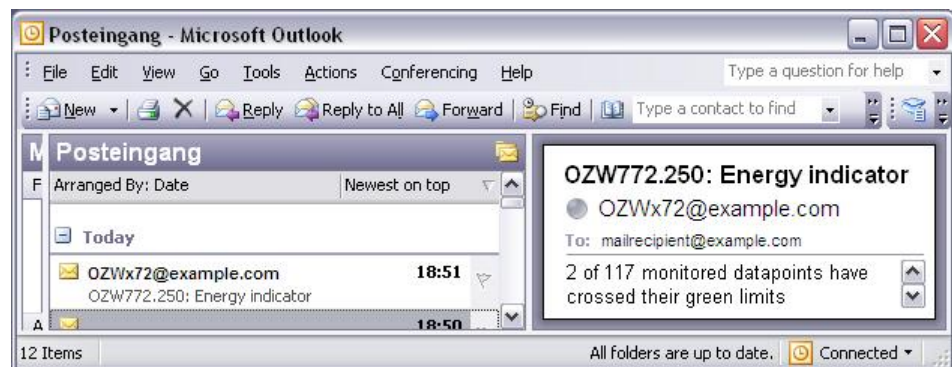

7.5.3 E-mail contents

E-mail Energy indicator contents

The contents of the e-mails comprises (see screenshot below):

- E-mail format Text only (see message field below).
- E-mail sender As per the settings (e.g. ozw772@siemens.com).
- E-mail Receiver As per the settings (e.g. first_name.lastname@example.com).

Reference field

The Reference field comprises the following information:

- Plant name: OZW type or user-defined name (see examples).
- Energy indicator Fixed text (e.g. "Energy indicator" translated into the language selected in the Web Server).

Examples

OZW772.250: Energy indicator

Lindenmatt 1: Energy indicator

Message field

The actual message is written in the language selected in the Web Server.

Example

2 of 117 monitored data points have crossed their Green limits.

10 lines follow this text where each line may contain a free text regardless of the language selected in the Web Server. (Signature line 1...10, with max. 49 characters per line).

E-mail "Energy indicator"



7.6 Exceptions

Regenerate bus devices

The following applies to the "Energy indicator" function when regenerating bus devices:

- Existing data points and their "Green limits" as well as the set status for "Data point monitoring activated/deactivate" remain as is.
- Data points no longer available and their "Green limits" are deleted from the "Energy indicator" database.
- New data points and their "Green limits" are taken over into the "Energy indicator" database and data point monitoring is activated.

Bus devices

Hide

Hiding bus devices is the same as deactivating monitoring. Thus, "Energy indicators" are not calculated and displayed.

Home | Energy indicator | Faults | File transfer | User accounts | Device web pages

Device name	Device address	Device type	Serial no	State	Generated on		
<input type="checkbox"/> OZW772.250	0.2.150	OZW772.250	00FD00FF0644	Generated	08.03.2012 07:55		
<input type="checkbox"/> QAX913	0.2.200	QAX913-DE	00FD000763FE	Generated	08.03.2012 08:03		
<input type="checkbox"/> RMH760B-1	0.2.210	RMH760B-1	00FD0007A091	Generated	08.03.2012 08:08		
<input type="checkbox"/> RMU730B-1	0.2.220	RMU730B-1	00FD0007980B	Generated	08.03.2012 08:06		
<input checked="" type="checkbox"/>				<input type="button" value="Add"/>	<input type="button" value="Delete"/>	<input type="button" value="Generate"/>	<input type="button" value="Hide"/>

Generate again

Bus devices are shown again via "Generate".

Change configuration

Complete changes to the configuration via "Generate".

Replace

Complete bus device replacements via "Generate".

Delete

When deleting bus devices from the device list, the "Energy indicator" data is deleted also.

Special cases

Bus device failure

In the event of bus device failure, e.g. no communication via KNX bus, the "Grey leaf" is displayed. The "Estimated processing time" does not change.

Missing bus supply

If there is no bus supply, the data point values of the bus devices cannot be read and a "Grey leaf" is displayed. The "Estimated processing time" does not change.

System data update

Complete system data updates for all bus devices via "Generate". "Generate" does not lead to data loss.

Firmware update

In the event of a firmware update, the entire configuration is lost, i.e. parameter set and data for the "Energy indicator" function.

Read and write of the parameter set via ACS790 allow for retaining the configuration of the OZW772... (device list and "Device Descriptions").

Changed data of the "Energy indicator" function are lost. The "Energy indicator" function starts with the data point values and "Green limits" similar to creating a device list in the Web Server.

8 Communications

8.1 Remote operation

Note



The Web Server is not suited for direct connection to the Internet, but rather must be connected through a firewall. A router typically includes a firewall.

The firewall must be configured to permit only outgoing connections. Incoming connections must be suppressed.

The Web Server can be operated from a PC with web browser on a local area network (LAN) or via the Internet. The following settings are valid as well for access via Smartphone App and other applications via Web API.

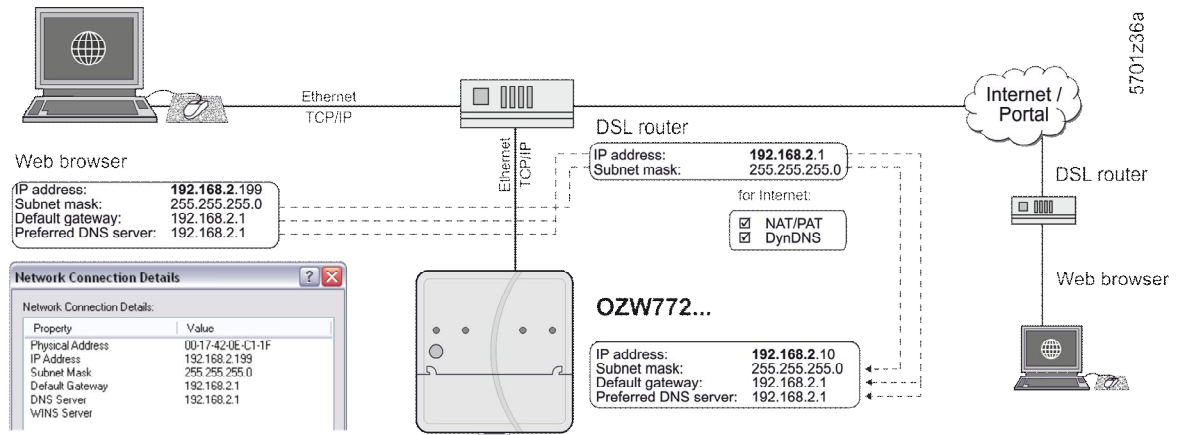

8.1.1 Access via portal

OZW registers automatically during commissioning as soon as it connects to the Internet.

All functions are available after the user also logs on to the portal and activates the plant. No further settings required on router. The workflow for accessing via the portal is described in Section 3.1 "Set up access via portal".

8.1.2 Access via Local area network (LAN)

The PC and Web Server must be on the same IP subnet to communicate. You must first determine the subnet as well as the IP addresses.

Local area network with router

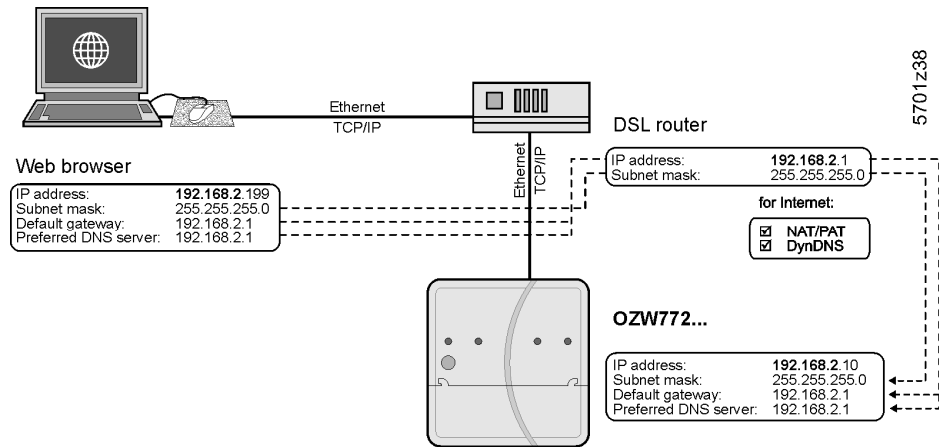

A router normally serves as the DHCP server if installed on a local area network (e.g. DSL router for Internet access). As such, it automatically assigns IP addresses to all participants that are DHCP clients.

If a PC is connected to the router via Ethernet, an IP address, subnet mask, standard gateway and DNS server are assigned automatically.

When delivered, the Web Server already contains an enabled DHCP client; as a result, users do not need to enter Ethernet settings.

The connection is checked every 3 minutes. It is recommended to assign the IP address of the Web Server in the router according to its MAC address.

If the router with DHCP server is not available, the Web Server uses the default IP address [192.168.2.10](#).

For manual settings, use the PC to determine the required data.

Procedure:

1. Select *Start > Control Panel > Network connections > Local Area Connection*.
2. Select "Support" tab.

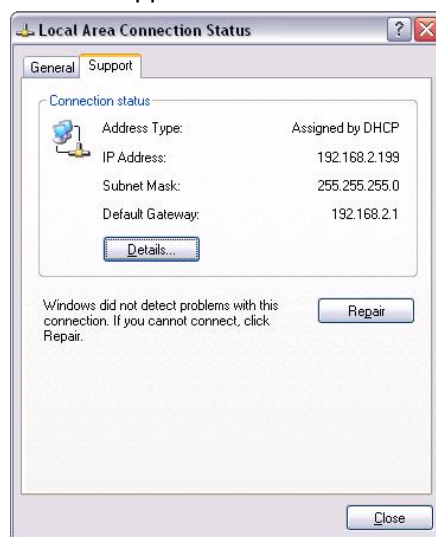

3. Click [Details...]

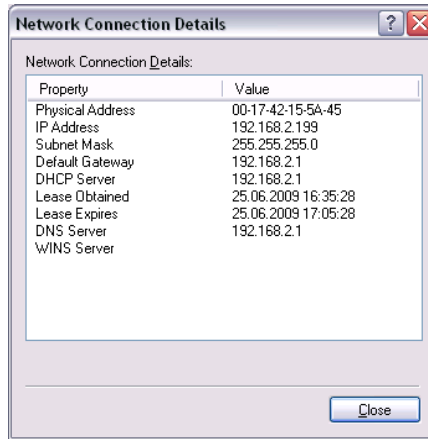

In the example, the PC is assigned the IP address [192.168.2.199](#) and subnet mask [255.255.255.0](#). The default gateway and DNS server have IP address [192.168.2.1](#).

You can use the data to set the Web Server:

- IP address: an unused address on the subnet. For example [192.168.2.10](#) is still available, if the PC uses [192.168.2.199](#) and the router uses [192.168.2.1](#).
- Subnet mask: [255.255.255.0](#)
- Default gateway: [192.168.2.1](#)
- Preferred DNS server: [192.168.2.1](#)
- Alternate DNS server (empty).

Notes



- In the example, the subnet has an address of [192.168.2.x](#). Devices must have the same subnet address to communicate directly (i.e. without a router).
- The Web Server is delivered as preconfigured DHCP client with automatic reception of the network configuration.
The Web Server's IP address can be set manually as an option.
- We recommend using IP addresses from the private range in the home network (see Section 11.3.1).

Local area network without router

IP addresses and subnet masks must be entered manually if a local area network is installed with PC and Web Server, but without a router.

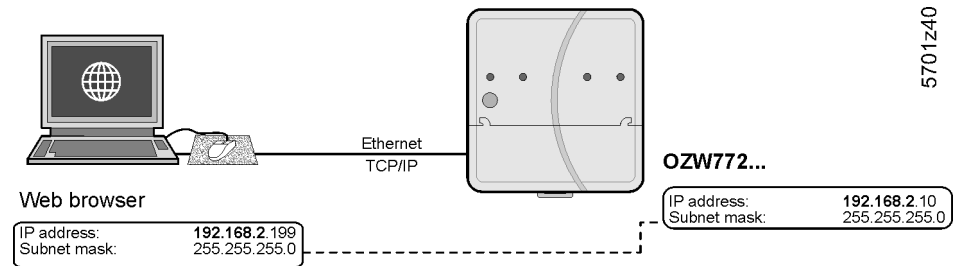

On the PC, set as follows:

1. Select *Start > Control Panel > Network connections > Local Area Connection*.
2. Select the "General" tab.

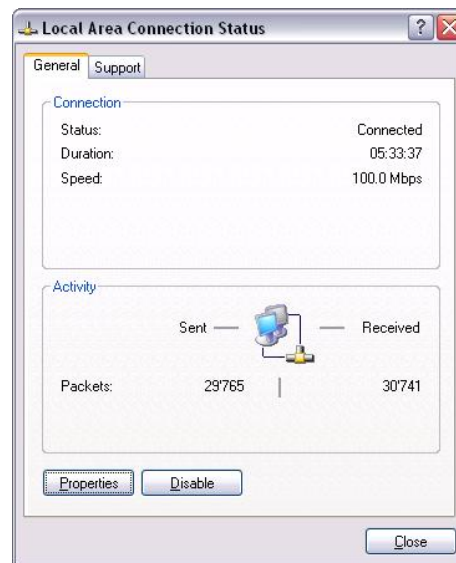

3. Click [Properties]

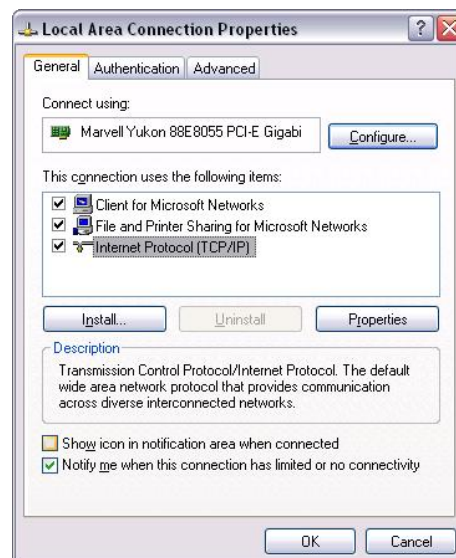

4. Select "Internet Protocol (TCP/IP)".
5. Click [Properties]
6. Select "Use the following IP address".

Continued on next page.

7. Enter the IP address and subnet mask.

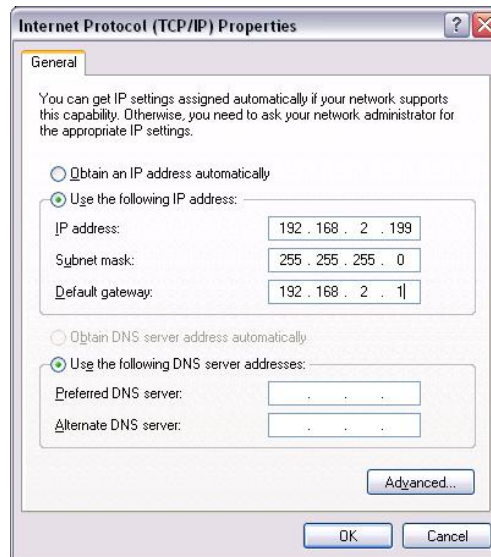

8. Click [OK]

In the example, the PC is assigned IP address [192.168.2.199](#) and subnet mask [255.255.255.0](#).

You can now set the Web Server:

- IP address: An unused address in subnet, e.g. [192.168.2.10](#)
- Subnet mask: [255.255.255.0](#)
- Default gateway (empty).
- Preferred DNS server (empty).
- Alternate DNS server (empty).

Notes



- In the example, the subnet has an address of [192.168.2.x](#). Devices must have the same subnet address to communicate directly (i.e. without a router).
- Settings for the standard gateway and DNS servers are irrelevant in a local area network without a router.
- We recommend using IP addresses from the private range in the home network (see Section 11.3.1).

8.1.3 Access via direct connection

Internet connection

An appropriate connection is required (e.g. DSL router) for a direct connection via Internet. Setting up Internet access is not described here. The Web Server is not suitable for connecting directly to the Internet, since it does not have a firewall. This is normally a component of the DSL router.

Notes



- The examples here were created using the Siemens Gigaset SX763 router. Workflows, terms, and functions vary by product used, the principle remains the same for all products. The router must support NAT/PAT, Dynamic DNS and, as an option, DHCP.
- The Web Server supports HTTPS (Hyper Text Transfer Protocol Secure). Web operating pages are transmitted secured and encrypted. The user is responsible for the use of unencrypted HTTP connection.
- Use a VPN connection is accessing via a fixed IP address.

Local area network (LAN)

IP address, subnet mask and DHCP are set up under Local Network in addition to other settings:

- The IP address router is fixed.
- The subnet mask defines the size of the subnet.
- The router assigns the DHCP clients (e.g. the PC on the local area network) an IP address from a selecting setting range ("First issued IP address" through "Last issued IP address") if set as DHCP server.
- The "Standard gateway" is typically the router's IP address as well.
- The "Lease time" defines how long a client maintains the IP address received from the DHCP server (the DHCP server regularly renews the client IP addresses).

Gigaset SX763 WLAN dsl

The screenshot shows the 'Local Network' configuration page of the Gigaset SX763 router. The page is titled 'Local Network' and has a navigation menu on the left with options: Internet, Local Network (selected), Wireless Network, Telephony, USB, and Administration. The main content area contains the following settings:

- IP address: 192 . 168 . 2 . 1
- Subnet mask: 255 . 255 . 255 . 0
- DHCP Server: On (selected), Off
- Lease time: 30 minutes
- First issued IP address: 192 . 168 . 2 . 100
- Last issued IP address: 192 . 168 . 2 . 199
- Default gateway: 192 . 168 . 2 . 1
- Preferred DNS server:
- Alternate DNS server:
- Domain name: dummy.porta.siemens.net
- Clients table with columns for MAC address and IP address. One client is listed with IP address 192 . 168 . 2

Buttons for 'OK' and 'Cancel' are at the bottom of the form.

SIEMENS

In the example, the router has a set IP address of [192.168.2.1](#) and receives subnet mask [255.255.255.0](#). As a DHCP server, it renews the IP addresses of the DHCP clients every 30 (in the above example) minutes. DHCP clients are assigned addresses from a range of [192.168.2.100](#) through [192.168.2.199](#). The router is the gateway between LAN and Internet.

Firewall

We recommend enabling the firewall to protect the local area network:

- Firewall: On

Gigaset SX763 WLAN dsl

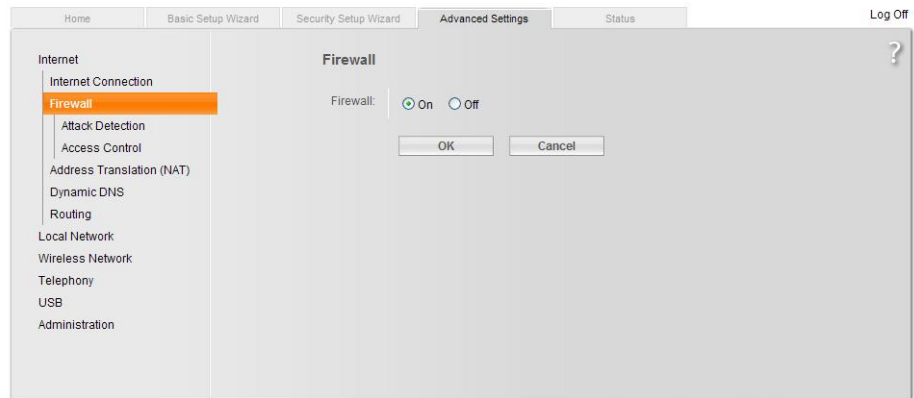

SIEMENS

Address translation (NAT)

Activate NAT to ensure that the Web Server can be reached via the Internet:

- NAT: On

Gigaset SX763 WLAN dsl

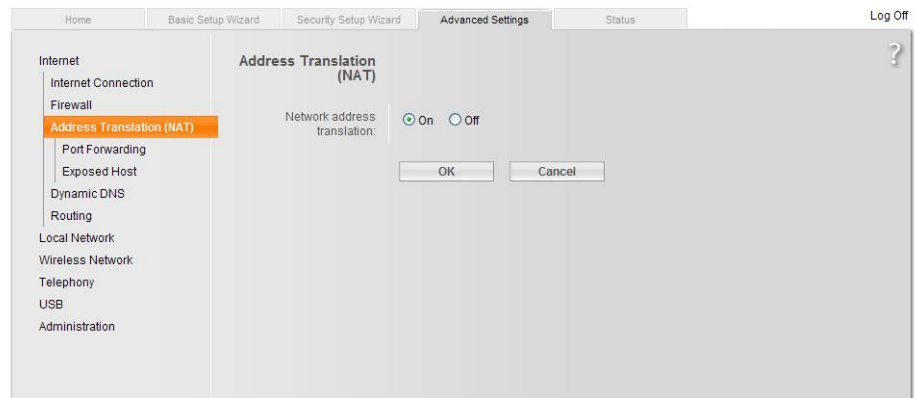

SIEMENS

Port forwarding (PAT)

- Port Forwarding is used to determine which local IP addresses/ports the router translates to which public IP addresses/ports.
- Web operating pages are preset on the Web Server via Port 80 (HTTP) or port 443 (HTTPS). As a result, queries from the Internet must be translated using the public IP address/port to the private IP address/port 80 or 443 for the Web Server.
- If the connection of the software ETS Tool is via the Internet, Port 3671 (reserved for ETS) must be translated by public as well as private IP addresses.
- When using PC software ACS790 for remote operation, you must also change Port 21 (FTP) and Port 50005 (ACS private) from the public to a private IP address.

Notes



- The port IP address is appended to the web browser address line: <IP address>:<Port>, e.g. 122.104.2.10:8080.
- The web browser always uses port 80 unless another port is entered. As a result, the information in the address line for the web browser is always: <IP address>:80 and <IP address>, or 122.104.2.10:80 and 122.104.2.10.
- Ports not equal to 80 are considered more robust against hackers.
- We recommend using Port Forwarding from the private range for ports (see Section 11.3.1).

Gigaset SX763 WLAN dsl

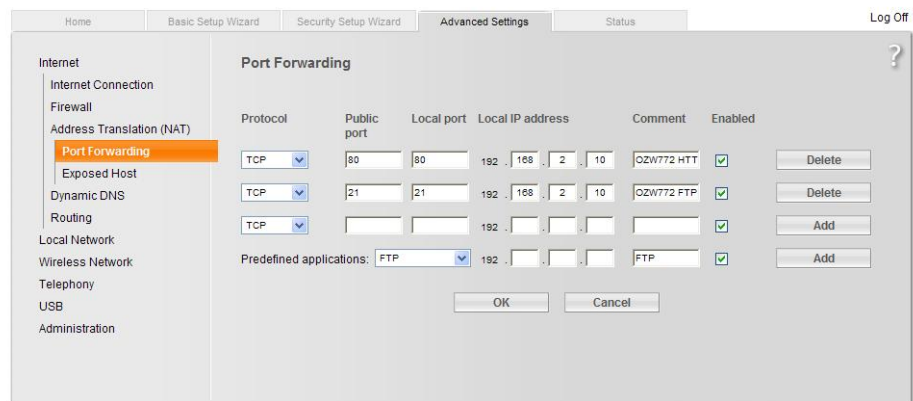

SIEMENS

In the example, queries from the Internet to a public IP address (Internet connection)/port 80 are forwarded to local IP address 192.168.2.10 (Web Server)/Port 80. Port 21 is also enabled for file transfer.

Dynamic DNS

The Web Server can communicate directly with the fixed IP address or domain if a fixed IP address or domain (e.g. www.myname.com) is available for the Internet connection.

Dynamic IP address

For dynamic IP addresses, the Internet provides free-of-charge Dynamic DNS services that connect user-defined domain names to dynamic IP addresses. The router must support Dynamic DNS to use this function.

Registration

To use the Dynamic DNS service, a new account must be set up at the respective provider.

Report dynamic address

The router must inform the service of changes to the dynamic IP address for the Web Server to communicate via the Dynamic DNS service setup. Set up the router Dynamic DNS as follows:

- Dynamic DNS: On
- Service provider: Service provider.
- Domain name Domain = Host name (own name).
- User name: User name for the Dynamic DNS account (e.g. MyUserAccount).
- Password: Password for Dynamic DNS account.

Gigaset SX763 WLAN dsl

The screenshot shows the 'Dynamic DNS' configuration page in the router's web interface. The page has a sidebar on the left with a tree view containing: Internet, Internet Connection, Firewall, Address Translation (NAT), Dynamic DNS (highlighted), Routing, Local Network, Wireless Network, Telephony, USB, and Administration. The main content area is titled 'Dynamic DNS' and includes a 'Dynamic DNS' toggle set to 'On', a 'Service provider' dropdown menu set to 'DynDNS.org', a 'Domain name' text field containing 'myhome.dyndns.info', a 'User name' text field containing 'MyUserAccount', and a 'Password' field with masked characters. At the bottom of the form are 'OK' and 'Cancel' buttons. The top navigation bar includes 'Home', 'Basic Setup Wizard', 'Security Setup Wizard', 'Advanced Settings', 'Status', and 'Log Off'. A question mark icon is visible in the top right corner of the main content area.

SIEMENS

Encrypted connection (HTTPS)

HTTPS encryption via port 443 is also supported. The required certificate is not accredited. The self-signed certificate from Siemens is valid for 20 years and is installed on the Web Server. The certificate must be installed on the web browser for encrypted communications.

Note



One own certificate must be installed for each Web Server.

Principal workflow

The web browser security warning is displayed the first time you connect via the https address. The page continues to load contrary to the web browser recommendation.

The certificate must now be installed: A context-sensitive installation routine is available depending on web browser used.

Note



The warning "Certificate error" remains for individual web browsers even after the certificate is successfully installed. Transmission is nevertheless secure.

8.2 Messages via e-mail

E-mail

SMTP is used to send fault messages, Energy indicator, system reports and Trend and consumption data via e-mail. The mail server (SMTP server, outgoing mail server) must be known to the Web Server to send e-mails to the Receivers (see Section 2.5.3.3 "Communication", E-mail).

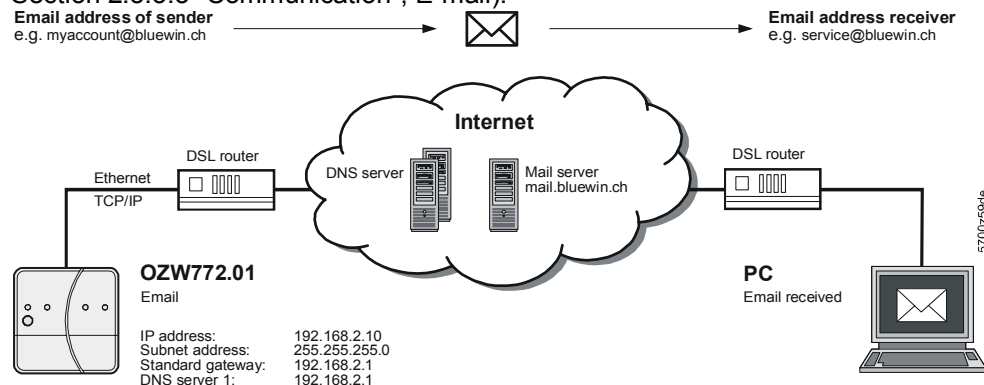

Prerequisites for sending e-mails via Internet:

- An e-mail account is available and set up (see Section 11.3.2, Free e-mail account providers).
- Internet access is set up for the Web Server (see Section 8.1.3).
- The settings for "E-mail", "Message receiver 1...4", "System report" or "Consumption data > Receiver" are made (see Section 2.5.3.3).

Example of an e-mail
(fault message)



Example of an e-mail
(consumption data)

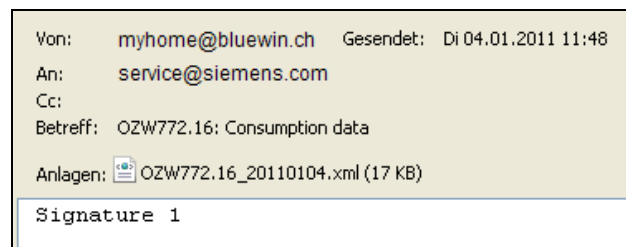

E-mail outline depends on message type and content.
In the listing below:

- User settings are in bold.
- The path for user settings starts each time with:
Home > 0.2.252 OZW772.16 > Settings > ...
- Set components of the e-mail are in italics.

Web Server fault

Example of an e-mail	Data point, information
<i>From:</i> myhome@bluewin.ch	...> Communication > E-mail: E-mail address sender
<i>To:</i> service@siemens.com	...> Message receiver > Message receiver 1...4: E-mail address
<i>Subject:</i> OZW772.16: Message central unit	...> Texts: Name: Message type
<i>Device:</i> OZW772.16 (0.2.252) Message: No bus power supply <i>Fault number:</i> 5000 <i>Fault priority:</i> Urgent Occurred at: 07-Oct-2010 at 3:15 pm	...> Texts: Name (Device address) Fault text Fault code Fault priority Occurred at
myhome.dyndns.info	...> Communication > E-mail: Signature line 1...10

Fault Synco device

Example of an e-mail	Data point, information
<i>From:</i> myhome@bluewin.ch	...> Communication > E-mail: E-mail address sender
<i>To:</i> service@siemens.com	...> Message receiver > Message receiver 1...4: E-mail address
<i>Subject:</i> OZW772.16: Message central unit	...> Texts: Name: Message type
<i>Device:</i> QAX913 (0.2.250) <i>Message:</i> No bus power supply <i>Fault number:</i> 5002 <i>Fault priority:</i> Not urgent Occurred at: 07-Oct-2010 at 3:23 pm	Name Synco device (device address) Fault text Fault code Fault priority Occurred at
myhome.dyndns.info	...> Communication > E-mail: Signature line 1...10

Fault eliminated

Example of an e-mail	Data point, information
<i>From:</i> myhome@bluewin.ch	...> Communication > E-mail: E-mail address sender
<i>To:</i> service@siemens.com	...> Message receiver > Message receiver 1...4: E-mail address
<i>Subject:</i> OZW772.16: Message central unit	...> Texts: Plant name: Message type
<i>Device:</i> OZW772.16 (0.2.252) or QAX913 (0.2.250) <i>Message:</i> No fault <i>Fault number:</i> 00 <i>Fault priority:</i> Not urgent Occurred at: 07-Oct-2010 at 3:23 pm	...> Texts: Plant name (device address) or Name Synco device (device address) Fault text Fault code Fault priority Occurred at
myhome.dyndns.info	...> Communication > E-mail: Signature line 1...10

System report with fault

Example of an e-mail	Data point, information
<i>From:</i> myhome@bluewin.ch	...> Communication > E-mail: E-mail address sender
<i>To:</i> service@siemens.com	...> Message receiver > Message receiver 1...4: E-mail address
<i>Subject:</i> OZW772.16: System report central unit	> Texts: Plant name: Message type
<i>Status:</i> N. OK <i>Fault 1:</i> <i>Device:</i> QAX913 (0.2.250) <i>Message:</i> *No bus power supply, 5002 Occurred at: 07-Oct-2010 at 3:42 pm	Status Fault 1: Name Synco device (device address) Fault text, fault code Occurred at
myhome.dyndns.info	...> Communication > E-mail: Signature line 1...10

System report
without fault

Example of an e-mail	Data point, information
<i>From:</i> myhome@bluewin.ch	...> Communication > E-mail: E-mail address sender
<i>To:</i> service@siemens.com	...> Message receiver > Message receiver 1...4: E-mail address
<i>Subject:</i> OZW772.16: System report central unit	...> Texts: Plant name: Message type
<i>Status:</i> OK	Status
myhome.dyndns.info	...> Communication > E-mail: Signature line 1...10

Consumption data

Example of an e-mail	Data point, information
<i>From:</i> myhome@bluewin.ch	...> Communication > E-mail: E-mail address sender
<i>To:</i> service@siemens.com	...> Consumption data > Message receiver > E-mail receiver 1...2 > E-mail address
<i>Subject:</i> OZW772.16: Consumption data	...> Texts: Plant name: Message type
<i>Plants:</i>	.xml or .csv file
myhome.dyndns.info	...> Communication > E-mail: Signature line 1...10

You can provide the required information as follows for an e-mail account under MS Outlook:

1. Start Outlook.
2. Go to Tools / E-mail accounts...
3. View or change existing e-mail accounts.
4. Click [Next >]
5. Select the desired account.
6. Click [Change]

The e-mail account dialog box is displayed with the data on the e-mail account.

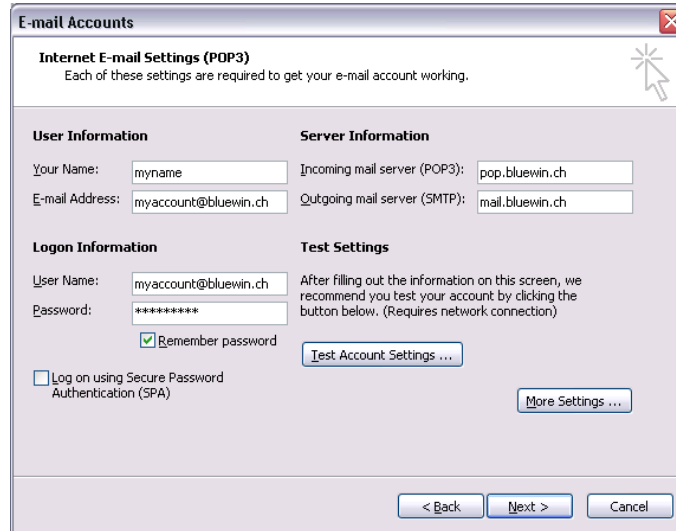

7. Click [More settings...]
If required, authentication is displayed here.

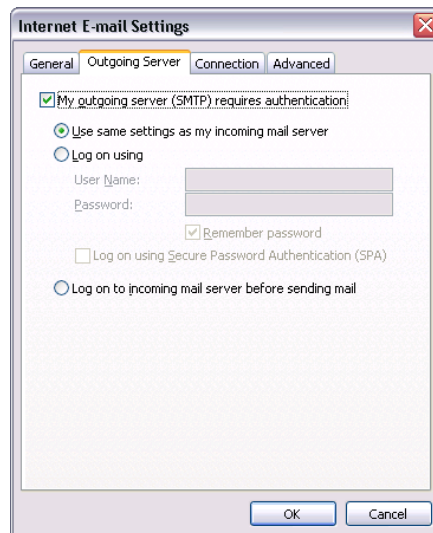

8. Click [Cancel] to exit the account settings.

Notes



- A list of providers that send e-mails at no charge is available in Section 11.3.2.
- The Web Server supports HTTPS (Hyper Text Transfer Protocol Secure). E-mails are transmitted unsecured and unencrypted.
- Web Server supports SSL (Secure Sockets Layer, network protocol for the secure transfer of data) and TSL (Transport Layer Security, encryption protocol for data transmissions over the Internet; a further development of SSL).
- "Authentication mail server = Yes" checks unsecured, unencrypted information in the data items "User name" and "Password" from the mail server for each e-mail transmission.
- The mail server can also be installed on the local area network.

9 Trend functions

9.1 Overview

The Web-Server OZW772... can create trends for any data points. The trend can be labeled with its own name and the sampling rate set. The maximum period of trending is derived from the number of data points selected and the sampling rate. A web browser is used to set the trend.

As an alternative, you can also set trends via the ACS Tool.

Select trend function

- Select the Web Server.
The **Home** page is displayed.

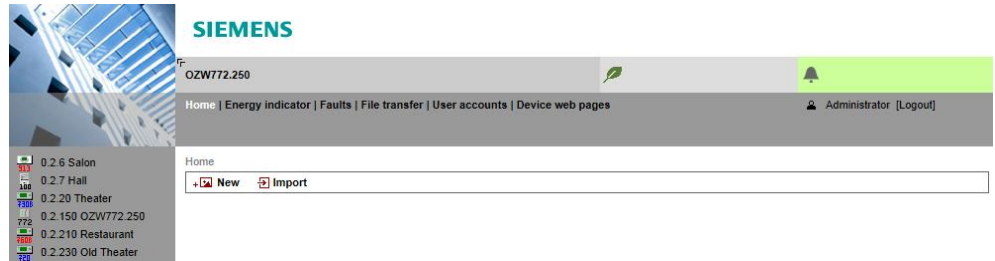

- Under primary navigation, select **File transfer** menu.

Home | Energy indicator | Faults | **File transfer** | User accounts | Device web pages

In secondary navigation on the left side of the window, the overview page **Trend** for the Web Server is automatically selected.

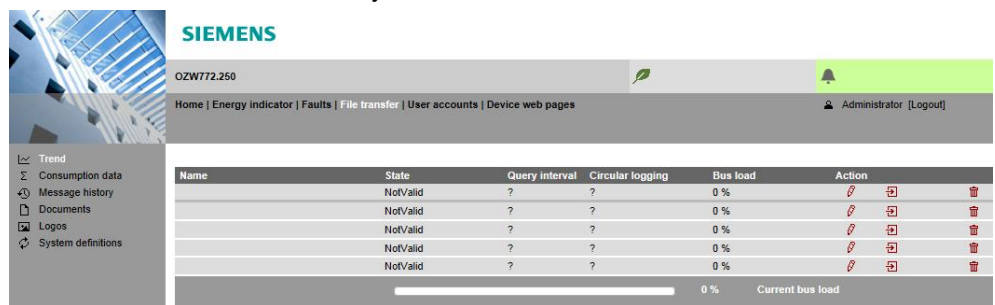

Trend overview appears as follows if not trend has been defined:

Name	State	Query interval	Circular logging	Bus load	Action
	NotValid	?	?	0 %	[edit] [delete]
	NotValid	?	?	0 %	[edit] [delete]
	NotValid	?	?	0 %	[edit] [delete]
	NotValid	?	?	0 %	[edit] [delete]
	NotValid	?	?	0 %	[edit] [delete]

0 % Current bus load

Trend overview appears as follows if trends have already been defined:

Name	State	Query interval	Circular logging	Bus load	Action
outside temperature	Running	15m	730 Days	0 %	[edit]
room temperature	Finished	15m	730 Days	0 %	[edit] [delete]
	NotValid	?	?	0 %	[edit] [delete]
	NotValid	?	?	0 %	[edit] [delete]
	NotValid	?	?	0 %	[edit] [delete]

0 % Current bus load

An active trend is highlighted in green.

Trend information



The following information is displayed for a maximum of 5 trends:

- Name
- Status
- Query interval
- Circular logging (length of the history window)
- Bus load per trend

The sum of the bus load for all active trends is displayed below the table using the "Bus load" bar.

Buttons

The red symbols in the trend overview are buttons with the following functions:

	Create or edit trend		Generate trend graph
	Start trend recording		Import trend definitions
	Stop trend recording		Export trend definitions
	Download trend data		Delete trend data and trend definitions

Trend states

A trend channel can have the following states:

Invalid: Trend is state **invalid** as long as no data points are defined in trend, e.g. in delivery state or after deleting a trend definition.

Process completed: The trend is in state "Process completed" as soon as data points are defined that the trend is stopped or not yet started".

Running: The trend is in state "In progress" if trend recording is started.

9.2 Define trend

9.2.1 Define trend via web

You define trends on the trend overview page.

1. Click the red pencil  to create or edit a trend. The **Edit** window opens.

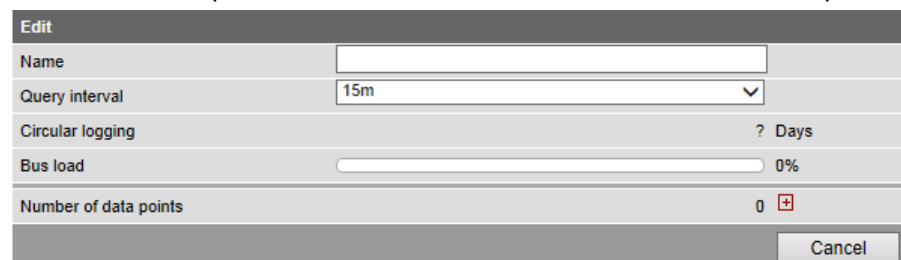

Edit	
Name	<input type="text"/>
Query interval	15m
Circular logging	? Days
Bus load	0%
Number of data points	0 
<input type="button" value="Cancel"/>	

2. Enter trend name.

- Select query interval (1 s, 2 s, 5 s, 10 s, 15 s, 30 s, 1 m, 2 m, 5 m, 10 m, 15 m, 30 m, 1 h, 2 h, 3 h, 6 h, 12 h, 24 h).

Edit	
Name	outside temperature
Query interval	15m
Circular logging	1s
Bus load	10s
Number of data points	Home > 0.2.230 Old Theater
	1s
	2s
	5s
	10s
	15s
	30s
	1m
	2m
	5m
	10m
	15m
	30m
	1h
	2h
	3h
	6h
	12h
	24h

- Click to add a data point. The **Data point address** is displayed with available devices.

Datapoint address	
Home	
Upward	
0.2.6 Salon	
0.2.7 Hall	
0.2.20 Theater	
0.2.150 OZW772.250	
0.2.210 Restaurant	
0.2.230 Old Theater	
	Cancel

As of OZW version 5.0, data points integrated in the system via KNX S-Mode (e.g. lighting, blinds, energy and volume measured values) are available to the trend function.

Datapoint address	
Home > 0.2.150 OZW772.250 > Living room	
Upward	
<input type="radio"/> Ceiling lights	
<input type="radio"/> Free-standing luminaire	
<input type="radio"/> Dimmer	
<input type="radio"/> Living room temperature	
<input type="radio"/> Room air quality	
<input type="radio"/> Energy consumption heating	
<input type="radio"/> Energy consumption hot water	
	Cancel

5. To record outside temperature in this example, the data point "Actual value outside temp" is used under "0.2.230 Old Theater>Inputs" .

6. The trend settings and the resulting, maximum trend length and bus load is displayed in the window. "Edit" displayed.
 Click to add up to a maximum of 100 data points.
 To conclude, confirm settings with **OK**.

The trend is created and automatically started.

Name	State	Query interval	Circular logging	Bus load	Action
outside temperature	Running	1m	728 Days	2 %	

Note



The query of a device is locked for one minute if a data point is unable to be read three times in a row due to a communications fault with the device. Other data points within the same trend as well as other trends are still queried. The queries continues normally after the lock out expires. Missing data points are listed in the trend file (.csv) with a "?". The missing data points are displayed as a break in the curve for the trend graph.

Trend synchronization

Trends are synchronized to simplify evaluation of trend data.

The various query intervals are set up on an interval grid. The interval grid begins at 00:00:00 hh:mm:ss.

A newly started trend displays the first data point at the first possible interval point after start. The trend has the state "Incomplete" as long as this point has not been reached; it then changes state to "In process".

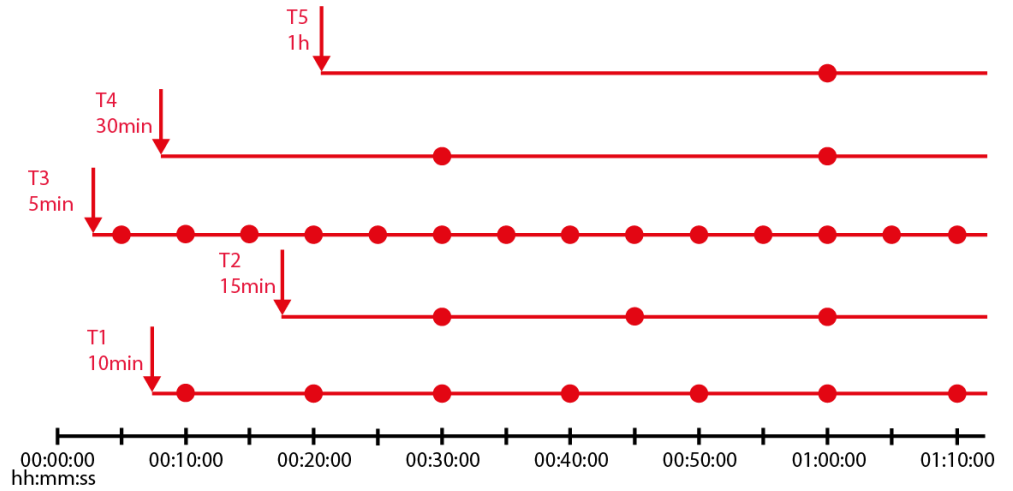











- T1-T5 Trend channel 1-5 and query interval
- XXmin
- ↓ Start time of trend
- Trend time for the corresponding data point

9.2.2 Restriction to bus load

Bus load by the trend function is restricted to 1 data point per second (corresponding to 100 %). The sum of the loads of all 5 trend channels cannot exceed this value.

No new trends can be started once the value is reached.

In the example below, the query interval of the outside temperature of 1 second already results in a bus load of 100 %. As a consequence, an additional query of the room temperature at 50 % load can no longer be started.

Name	State	Query interval	Circular logging	Bus load	Action
outside temperature	Running	1s	12 Days	100 %	 
room temperature	Finished	2s	3 Days	50 %	  
	NotValid	?	?	0 %	  
	NotValid	?	?	0 %	  

100 % Current bus load

Any attempt to start this trend results in a warning.



9.2.3 Reset trend definition

Trends can be reset to the default settings.

The default settings for the values are as follows:

- Interval = 15 Min
- Number of data points = 0
- Status = Invalid
- History window = ? days
- Bus load = 0 %
- Trend name = ""

Note



Any associated trend data is deleted when the trend definition is reset.

Procedure

1. Click the red waste can symbol .
The confirmation window **Delete** of the trend data opens.



2. Confirm delete of trend data with **OK**.
The trend settings and data is deleted.

9.2.4 Add trend data points

Add data points

Additional data points are added to an existing trend as follows:

1. Click the red pencil symbol  to open an existing trend. The **Edit** window opens.

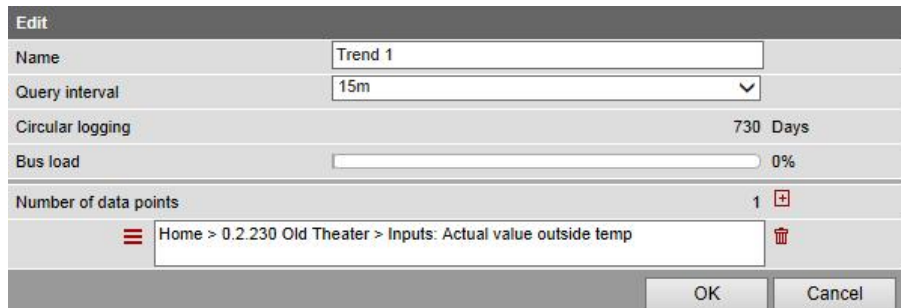

The screenshot shows the 'Edit' window for 'Trend 1'. The 'Number of data points' is 1. The data point list contains one entry: 'Home > 0.2.230 Old Theater > Inputs: Actual value outside temp'. The 'Circular logging' is set to 730 Days and 'Bus load' is 0%.

2. Use the plus symbol  to add an additional data point address as data point to the trend. The selected data points are listed in the data point list.

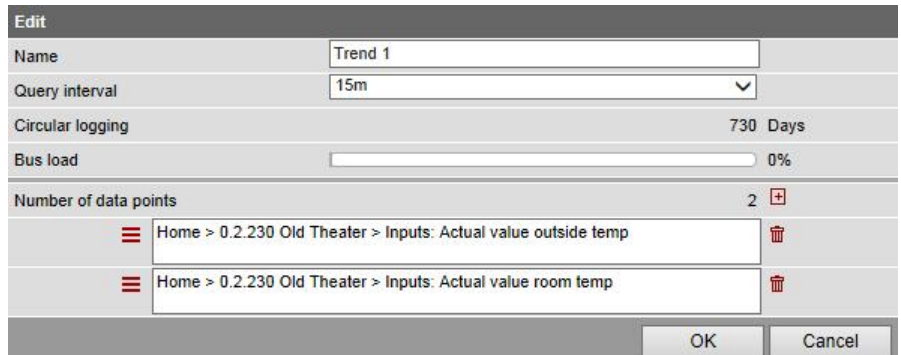

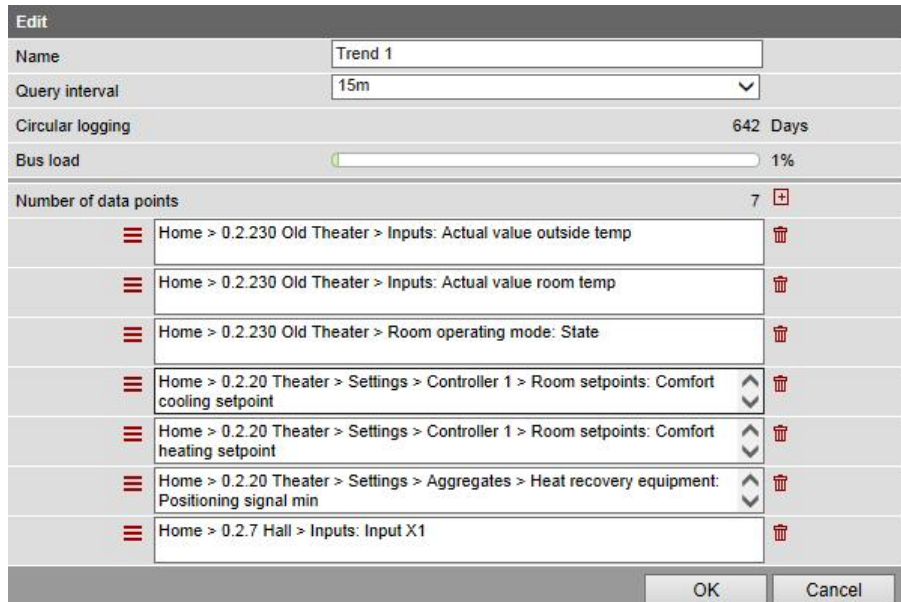

The screenshot shows the 'Edit' window for 'Trend 1'. The 'Number of data points' is 2. The data point list contains two entries: 'Home > 0.2.230 Old Theater > Inputs: Actual value outside temp' and 'Home > 0.2.230 Old Theater > Inputs: Actual value room temp'. The 'Circular logging' is 730 Days and 'Bus load' is 0%.

3. You can add a maximum of 100 data points to the trend using the plus symbol . Bus load and trend period is adapted to the number of data points accordingly.



The screenshot shows the 'Edit' window for 'Trend 1'. The 'Number of data points' is 7. The data point list contains seven entries: 'Home > 0.2.230 Old Theater > Inputs: Actual value outside temp', 'Home > 0.2.230 Old Theater > Inputs: Actual value room temp', 'Home > 0.2.230 Old Theater > Room operating mode: State', 'Home > 0.2.20 Theater > Settings > Controller 1 > Room setpoints: Comfort cooling setpoint', 'Home > 0.2.20 Theater > Settings > Controller 1 > Room setpoints: Comfort heating setpoint', 'Home > 0.2.20 Theater > Settings > Aggregates > Heat recovery equipment: Positioning signal min', and 'Home > 0.2.7 Hall > Inputs: Input X1'. The 'Circular logging' is 642 Days and 'Bus load' is 1%.

- Notes  The data points within a trend are all queried at the same interval. The entire path for a data point is always displayed simply identifying the source of the data point.
- Sort data points** Data points can be moved within the list. Simply left-click the sort symbol  for the data point and keep it pressed until the data point is moved to the new position.
- Delete data points from the list** A single left-click of the waste can symbol  deletes the data point from the data point list without additional confirmation.

9.2.5 Manage trend RAM

A fixed RAM (flash) size is assigned to each trend channel. Trend channel 1 has more RAM and is particularly well suited for long-term trending with a number of data points, or a high query interval.

- Trend channel 1: 14 MB
- Trend channel 2...5: 2 MB

The read data is written first to RAM while trending. It is transmitted to Flash memory every 60 minutes. A maximum of one hour of trend data is lost in the event of a power outage.

9.3 Send trend data by e-mail

Trend data can be sent as an appendix to an email.

Settings to send trend data by e-mail occur in the following area:

1. In primary navigation, click **Home**.
2. In secondary navigation, click **0.x.y OZW...**
3. Click **Settings**.
4. Click **Trend**.

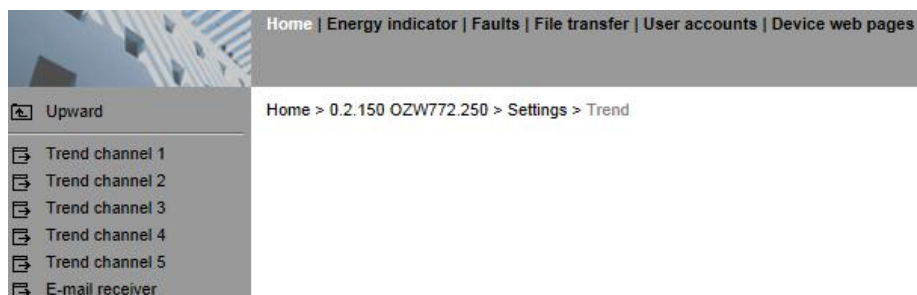

In secondary navigation, the menus **Trend channel 1...5** and **E-mail receiver** are now available.





9.3.1 Configure E-mail receiver

OZW can send trend data to a total of 2 e-mail receivers for each trend channel. The receiver addresses are set as follows:

1. In secondary navigation, click **E-mail receiver**.

The window with the e-mail addresses for both message receivers opens:

Home > 0.2.150 OZW772.250 > Settings > Trend > E-mail receiver

Datapoint	Value
E-mail receiver 1	
E-mail address	mailrecipient@example.com 
Test receiver	--- 
Trend data sent	---
Cause	---
E-mail receiver 2	
E-mail address	mailrecipient@example.com 
Test receiver	--- 
Trend data sent	---
Cause	---

2. Click **E-mail address** of the desired receiver 1 or 2 or the red pencil symbol .

The **Edit** window opens.

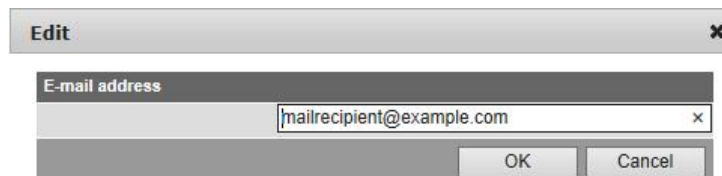

3. Enter the desired e-mail address.
4. Click **OK** to confirm.

Send test e-mail to receiver

You can send a test e-mail to the receiver to ensure the settings are correct.

1. Click **Test receiver** or the red pencil symbol .
2. In the **Edit** window, select the **Trigger** option.

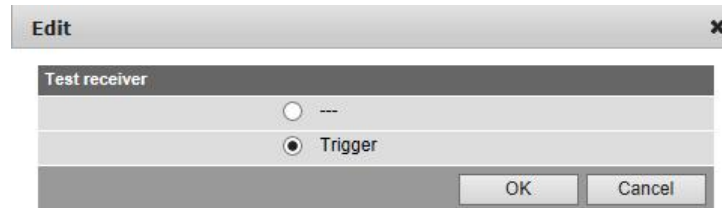

3. Confirm with **OK**.
OZW sends a test e-mail to the entered receiver and confirms the transmission under the data point **Trend data sent** with **Yes**.
If transmission failed, a possible cause is provided under **Reason**, see Section 2.7, Functional check, "Test message receiver".
4. Check whether the e-mail arrived at the receiver.

Note





E-mail receiver settings are retained when deleting or overwriting an existing trend definition.

9.3.2 Sent transmission options per trend channel

The transmit interval can be set separately for each trend channel 1...5.

1. In secondary navigation, select desired **Trend channel 1...5**.
The window displays name, state, circular logging, transmit interval, and message receiver.

Home > 0.2.150 OZW772.250 > Settings > Trend > Trend channel 1

Datapoint	Value
Trend channel 1	outside temperature
State	Running
Circular logging	730 d
Transmit interval	Automatic 
Message receiver	Receiver 1+2 

Set transmit interval

1. Click **Transmit interval** or click the red pencil .
The edit window opens.

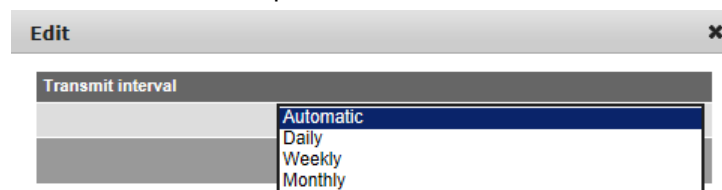

2. Set the desired transmit interval.
The following options are available:
Automatic (default value): The e-mail is sent after the history window expires. All trend data is sent going back to the start of trend logging.
Daily: An e-mail is sent each day. All trend data is sent from the last day.
Weekly: An e-mail is sent every week. All trend data is sent from the last week.
Monthly: An e-mail is sent each month. Trend data for the last month is sent.
3. Click **OK** to confirm

Notes



An e-mail is always sent when a trend is stopped.
An e-mail is only sent while trend logging is on-going.
This does not interrupt trend logging.
The data in the OZW RAM is not deleted after the e-mail is sent.
The start time for a day is 00:00:00 (hh:mm:ss). As a result, all sent reports start at the same time and can be easily compared and processed.

Set message receiver

1. Click **E-mail receiver** or click the red pencil .
The edit window opens.

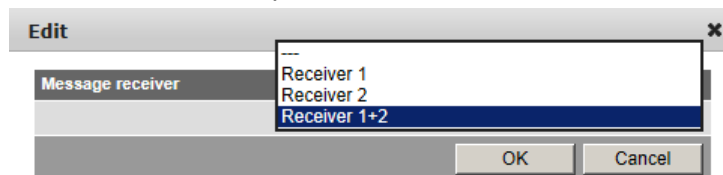

2. Set the desired e-mail receiver for this trend channel.
The following options are available:
--- : No transmission of e-mails from this trend channel
Receiver 1: Transmission to receiver 1
Receiver 2: Transmission to receiver 2
Receiver 1 + 2: Transmission to receiver 1 + 2

9.3.3 E-mail content and appendix

E-mail content

The plant and trend name appear in the subject line for the e-mail:



The file name of the appendix is composed as follows:

- trend_data_x_ (with x representing trend channel 1...5)
- Creation date (yyymmdd)

In addition, the text field lists the current status of the corresponding trend:

State: Running: Trending is still running.

State: Completed: Trending is completed.

Appendix content

The appendix to the sent e-mail is a .csv (comma-separated values) file and can be opened using a common spreadsheet programs and text editors.

Example of a view in Excel:

	A	B	C	D	E	F	G	H
1	Plant information							
2								
3	Plant name	Device address	Device type	Serial number	IP address	File created on	File version	
4	OZW772.250	0.2.150	OZW772.250	00FD00FF0B5B	192.168.2.7	02:35 05.09.2013	1	
5								
6	Trend channel 1	outside temperature						
7	Query interval	5m						
8	Beginning	09:44:26	04.09.2013					
9	End	02:34:26	05.09.2013					
10								
11	Date	Time of day	Home > 0.2.230 Old Theater > Inputs: Actual value outside temp					
12	04.09.2013	09:44:26	22.8					
13	04.09.2013	09:49:26	22.8					
14	04.09.2013	09:54:26	23.1					
15	04.09.2013	09:59:26	23.1					
16	04.09.2013	10:04:26	23.1					
17	04.09.2013	10:09:26	23.1					
18	04.09.2013	10:14:26	23.1					
19	04.09.2013	10:19:26	23.3					
20	04.09.2013	10:24:26	23.3					
21	04.09.2013	10:29:26	23.5					
22	04.09.2013	10:34:26	23.5					
23	04.09.2013	10:39:26	22.8					
24	04.09.2013	10:44:26	22.8					

The file includes the following information, in addition to the actual trend data with date, time, and value:

- Plant name
- Device address
- Device type
- Serial number
- IP address
- Date and time of file creation
- File version
- Number and name of the trend channel
- Query interval
- Beginning
- End (last trend item prior to transmitting trend data)
- Path and data point name of trend

9.4 Download trend file via web

Trend data can be downloaded via the OZW web user interface.

Notes



Downloading via the web does not influence transmission of the data by e-mail. Logging of trend data continues unabated while downloading via web.

Trend data is downloaded via web as follows:

1. Under primary navigation, select **File transfer** menu (see Section 9.1 "Overview").
2. For the desired trend, click the symbol **Download trend data**
3. In the **Period** pane, the time can be set to download the trended data. The maximum number of days that can be downloaded at one time is displayed using "Maximum data content" and amounts to:
 - Trend channel 1: ca. rolling trend / 14 (channel 1 is 7 x larger than Channel 2...5)
 - Trend channel 2...5: ca. rolling trend / 2
 The trend period is displayed under "Circular logging".

Period		
Max data content	1 Days	Circular logging
Beginning		
Time of day	00:00	09:17:23
Date	03.10.14	03.10.2014
End		
Time of day	23:59	16:48:10
Date	03.10.14	04.10.2014
		OK Cancel

4. Click the calendar symbol to select the beginning and end of the period and select the desired day. The period always begins at 00:00 and ends at 23:59 of the selected day.

Period		
Max data content	1 Days	Circular logging
Beginning		
Time of day	00:00	09:17:23
Date	03.10.14	03.10.2014
End		
Time of day		
Date		
		Cancel

October 2014

Wk	Mo	Tu	We	Th	Fr	Sa	Su
40			1	2	3	4	5
41	6	7	8	9	10	11	12
42	13	14	15	16	17	18	19
43	20	21	22	23	24	25	26
44	27	28	29	30	31		

5. Confirm the selected period with **OK**.
6. The **Export** window may be displayed for larger amounts of trend data. The window is skipped for smaller files.

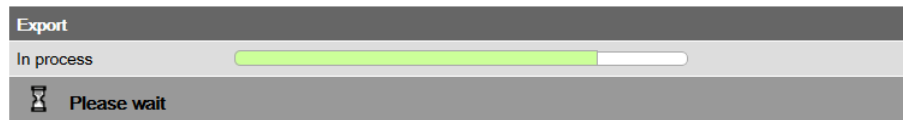

Note



Files can be exported whether trends are ongoing or stopped.

Download last encoded file

Another possibility exists, in addition to direct save of data on the PC (Step 7). The link to the last encoded file is displayed at the bottom of the window.



Click to download and is available at a later date. The next time a file is encoded, the link is replaced by the newer link.

9.5 Graphical trend display

The trend data for a trend channel can be graphically displayed on the OZW web user interface. The function is available for OZW772... as of version 6.0.

Note



The selected trend channel continues to operate while displayed graphically.

Procedure

Click the trend graphic symbol to generate the graph for the desired trend and display below the list of active trend channels.

The last 150 intervals of the selected trend channel are displayed.

The data point series are displayed in different colors when multiple data point series are displayed in the same trend.

The graph scales automatically based on the smallest and largest values.

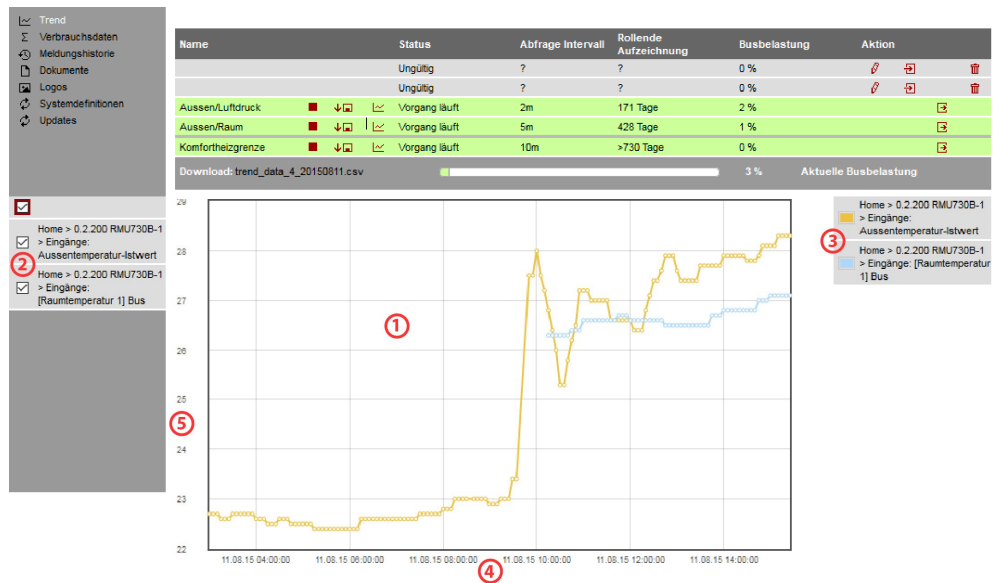

- ① Trend graph
- ② Individual data point series can be shown and hidden in the checkbox. The red-framed master checkbox selects and clears all data series. Only the selected data point series are displayed in the key
- ③ Key of curves with associated color and name of the data point series
- ④ Time axis with data and time
- ⑤ Unit axis as per the data point series

The content of the graph can be zoomed in/out by scrolling.

The cursor can move the position of the graph.

Move the cursor over an individual data point to display the associated data point name, timestamp, and value.

Note



Only data points with numbers are displayed, not "Text" data points. An empty graph without a key is displayed if no data is available for display.

The graph is only visible for the user that generated the graphic.

Other users are blocked for a short time while the graph is being generated.

Display multiple trend channels

Only one trend channel can be graphically displayed in each browser pane.

Another browser pane required to display another trend channel simultaneously.

9.6 Import/export trend definitions

Trend definitions can be exported and imported as a file.

The following buttons Export  and Import  are available to this end. The export is individual for each trend channel.

Note

Export/Import includes only the trend definitions. The logged trend data is neither exported nor imported.

Export trend definition

1. Under primary navigation, select **File transfer** menu (see Section 9.1 "Overview").
2. On the desired trend channel, click **Export**  symbol.
3. In the following window, select **Save**. The views differs by browser.
The file name is formed as follows:
- trendx.trx (with x representing trend channel 1...5).

Example with Internet Explorer

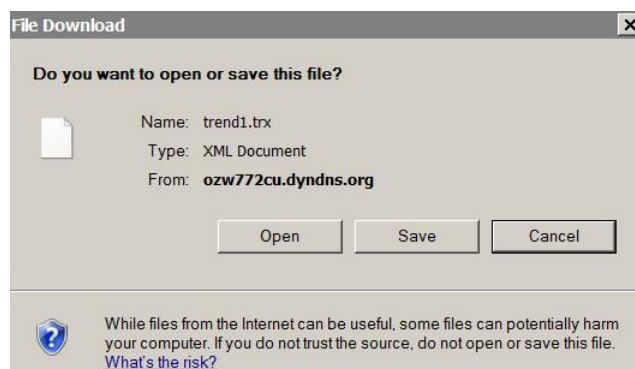

Example with Firefox

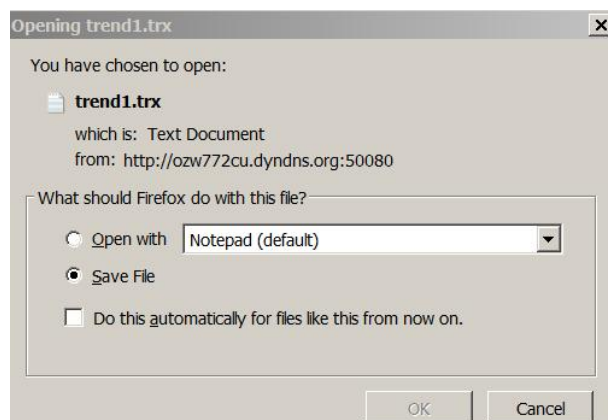

Note



The trend definition can be exported during trending.
On compatibility with ACS, see Section 9.7.1 "ACS offline trend compatibility".

Import trend definition

1. Under primary navigation, select **File transfer** menu (see Section 9.1 "Overview").
2. For the desired trend channel, click **Import** .
A request is displayed to delete existing trend data if the trend channel was previously used.



3. Confirm with **OK**.

- In the following window, **Browse** to select the file with the desired trend definition.

Import

File name (*.trx) Browse...

OK Cancel

- Click **Open** to confirm.
- The name of the selected file is displayed.

Import

File name (*.trx) Browse...

OK Cancel

- Click **OK** to confirm.
- The data point address must be changed in the following window if the device of the trend definition for import does not match with the device on the plant; true even if the data point matches (the data point address is specific to the device).

Replace datapoint addresses

0.2.230 0.2.150

OK

- Select checkbox.
- Select the desired data point address from the drop-down list.

Replace datapoint addresses

0.2.230 0.2.150

- 0.2.150
- 0.2.230
- 0.2.6
- 0.2.20
- 0.2.210
- 0.2.7

OK

- Confirm with **OK**
In the display example, the address 0.2.230 is retained since it is an import within the same device.
- You can check the settings for import in the following window and change as needed.

Edit

Name

Query interval

Circular logging 730 Days

Bus load

Number of data points 1

Home > 0.2.230 Old Theater > Inputs: Actual value outside temp

OK Cancel

The field turns orange if the selected data point address is unavailable. The data point address must be corrected to a valid value prior to confirmation.

Edit	
Name	outside temperature
Query interval	5m
Circular logging	? Days
Bus load	0%
Number of data points	1
Home > 0.2.230 Old Theater > Inputs: Actual value outside temp	
OK Cancel	

13. Click **OK** to confirm.

14. The Save window opens with another warning that the previous trend data of the trend channel is deleted.

Save	
Trend data will be deleted	
? Delete?	OK Cancel

15. Click **OK** to confirm the action.

Trend data is imported and the trend goes to the defined state as per the imported file:

- A trend exported in the state "Running" is started automatically after the import is completed, as long as bus load does not exceed 100%.
- A trend exported in state "Completed", is not started after import.

Note



Only trend definitions of version V2.0 can be imported.

Copy trend definition within OZW

A trend definition can be copied as follows within the same OZW:

1. Export trend definition for the desired trend channel.
2. Import trend definition to another trend channel.

9.7 ACS Trend

9.7.1 ACS offline trend compatibility

ACS V9.00 or older

Offline trend definitions from ACS V9.00 or older can still be written to OZW, run there and read.

Trends are listed on the OZW trend overview page, but cannot be exported or edited there. They are displayed in gray on the overview page and the buttons are hidden.

A struck out pencil symbol indicates that this trend cannot be edited in OZW. These trends may only be operated via ACS.

Name	Status	Abfrage Intervall	Rollende Aufzeichnung	Busbelastung	Aktion
Test Trend ACS	Vorgang läuft	?	3 Tage	20 %	
	Ungültig	?	0 Tage	0 %	
Test 3	Vorgang läuft	1m	145 Tage	2 %	
	Ungültig	?	0 Tage	0 %	
	Ungültig	?	0 Tage	0 %	

22 % Aktuelle Busbelastung

The interval cannot be displayed in this case and is displayed with "?".

Warning

For ACS V9.00 or older, the web-defined trends cannot be read and are therefore unavailable. ACS writes its trend definitions to the first, as viewed from ACS, available trend channel. As a result, a web-defined trend can be overwritten without warning.

ACS as of V9.01

As of ACS V9.01, the ACS and OZW trend definition is compatible. The trends can be defined or edited in ACS or OZW.

The trend in OZW synchronizes if an explicit start time is selected in ACS when defining the trend, similar to the trends defined in OZW using the interval grid (see Section 9.2.1).

No synchronization occurs if a trend is started in ACS with "Start now".

When editing an ACS trends in OZW (as of version 6), unknown trend intervals are set to the default interval of 15 min.

Note



A trend created in OZW or as of ACS V9.01 cannot be edited or displayed with ACS V9.00 or older versions.

Write trends defined in ACS via ACS to OZW (and not trend export/import).

9.7.2 ACS trend bus load

ACS V9.00 or older

The bus load of an ACS trend is displayed at a fixed value of 20%. This corresponds to the maximum possible load.
A trend written via ACS automatically changes to the status established by the trend definition.

ACS as of V9.01

The bus load of an ACS trend is displayed with the current value.
The trend automatically changes to the state established in the trend definition.

Note



The trend is only started for a trend definition of "Running" if the resulting overall bus load does not exceed 100%.

10 KNX S-Mode

Web Server OZW772... supports KNX S-Mode.

This section describes the supported properties for KNX S-Mode.

S-mode

"S-Mode stands for system mode. This mode primarily is characterized by the assignment of (logical) group addresses to S-mode data points to communicate process values.

Supported properties

OZW772.01 supports the following functions:

- System time
- Alarm info

The following supplemental functions are integrated as of version OZW772.04/16/250:

- Lighting control
- Blinds control
- Temperatures from third-party products
- Energy values
- Scene control

This permit central control of heating, ventilation, air conditioning, and electrical installations.

Data points recording by OZW can be used, for example, for trending, to depict the plant diagram or to calculate thermal or electrical energy consumption.

Example for showing KNX data points in a plant diagram:

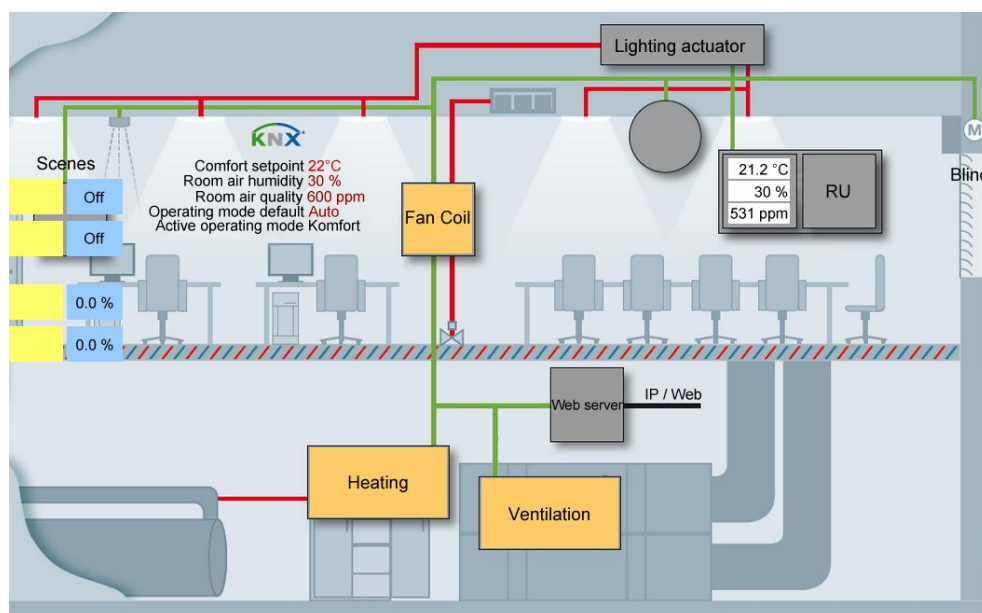

KNX interfaces The Web Server OZW772... also assumes the KNX interface (KNXnet/IP) using its built-in Ethernet interface.
Separate devices to connect the ETS to the KNX bus via Ethernet are no longer necessary.

Group monitoring Web Server OZW772... supports the ETS diagnostic function "Group Monitoring" as of version 6.

Acronyms

Abbr.	Meaning
DP	Data point
DPT	Data point type.
ETS	Engineering Tool Software.
KNX	Konnex
S-mode	System mode (communication mode in KNX networks).

Additional information Addition information on KNX and Synco devices with S-Mode data points can be found in document CE1Y3110.

10.1 Configuration in KNX S-Mode

Configuration/commissioning workflow

After installing the controller and the Web Server, the plant is commissioned as follows:

- Plant commissioning via ETS (addressing and S-Mode binding)*
- Controller commissioning with ACS*
- Web Server commissioning via web browser or ACS
- Generate web pages on the Web Server.

Important note



* Both tools include parameters for RDG/RDF controllers, but ETS can only write. Reset is only possible with ACS790. The tool sequence is important to ensure a valid configuration and backup: First ETS and then ACS.

ETS

The ETS software permits planning and commissioning of KNX installations of all sizes.

ETS is a registered trademark of the KNX Association (www.knx.org) and can be purchased and downloaded via its website. Product data for OZW772... is compatible with ETS as of version 4 and 5.



In ETS, the actual building (apartments, rooms), including all KNX devices and wiring structures are mapped virtually. Sensors and actuators are connected as desired.

The finished configuration is saved as a project and loaded to the Web Server and other participating devices.

Data points

Sensors and actuators are mapped as data points.

The format and number of bits, bit coding, value range and, where required, the unit (°C, %, m3/h, etc.) are specified in each data point type.

KNX S-Mode data points receive, with ETS, all attributes needed so that only the web page can be generated with the web browser.

Number of data points

A maximum of the following data points can be used depending on the device type:

- OZW772.01 7 DP
- OZW772.04 237 DP
- OZW772.16 237 DP
- OZW772.250 237 DP

A data point can be used multiple times but then is also counted multiple times.

Placing data points on the pages

The Web Server supports 10 KNX S-Mode pages that can be used to place the data points.

Any number of data points can be used per page as long as the maximum number of usable data points is not exceeded.

An update takes up to 70 second for 237 S-Mode data points on the same page. We recommend grouping the data points in a logical manner and spreading them out over various pages.

Page names

The pages can be given names in ETS with a maximum of 20 characters. As a default, they are numbered with KNX page 1 ... KNX page 10.

Allowable characters for names:

a-z, A-Z, 0-9, space ! " # \$ % & ' () * , - . / : ; < = > ? @ [] \ ^ _ ` { } | ~
(ASCII 20-7Fh)

Typical page names include:

- Living room, kitchen, bedroom, kids rooms, etc.
- or
- Lighting, blinds, temperature values, energy values, etc.

Example

Page names in ETS4/ETS5

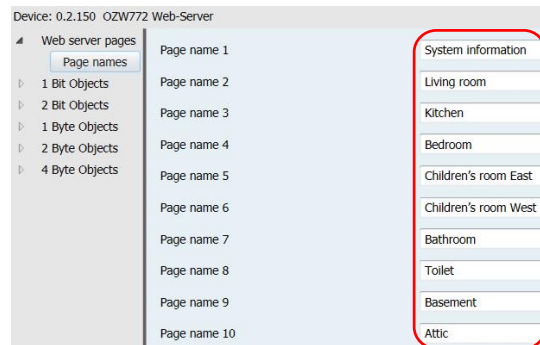

Page names in OZW772...

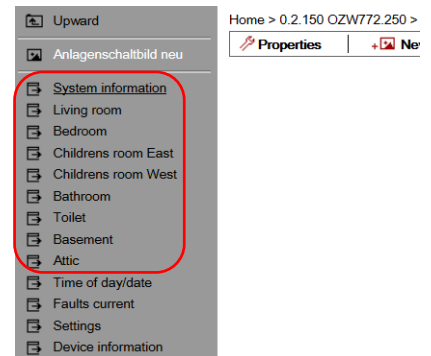

ETS issues an error message if you exceed the maximum entry length of 20 characters.

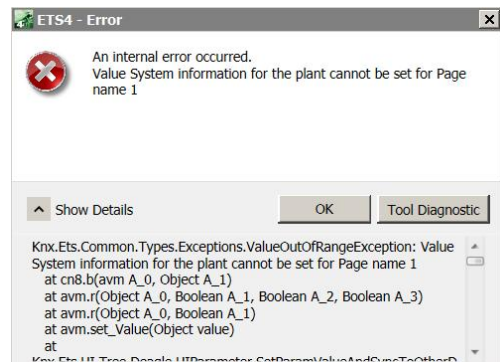

Data point names

Each data point can be assigned a name in ETS up a maximum of 36 characters. The same characters as for page names are allowed.

Typical data point names include:

- Time
- Ceiling light living room
- Floor light living room
- Blinds 1 living room
- Temperature sensor outside B9
- Temperature sensor boiler B10
- Energy consumption heating

Example

Data points in ETS4/ ETS5

Device: 0.2.150 OZW772 Web-Server

Web server pages	Value 1 (Change)	Yes
Page names		
1 Bit Objects	Data point type	1.001 Off/On
1 Bit Value Change/Display	Data point name 1	Ceiling lights
1 Bit Value Change	Web server page	Page 2
1 Bit Blind		
1 Bit Value Display		

Data points in OZW772...

Upward	Home > 0.2.150 OZW772.250 > Living room																
Anlagenschaltbild neu	<table><thead><tr><th>Datapoint</th><th>Value</th></tr></thead><tbody><tr><td>Ceiling lights</td><td>---</td></tr><tr><td>Free-standing luminaire</td><td>Off</td></tr><tr><td>Dimmer</td><td>0.0 %</td></tr><tr><td>Living room temperature</td><td>--- °C</td></tr><tr><td>Room air quality</td><td>819.84 ppm</td></tr><tr><td>Energy consumption heating</td><td>0 kWh</td></tr><tr><td>Energy consumption hot water</td><td>0 kWh</td></tr></tbody></table>	Datapoint	Value	Ceiling lights	---	Free-standing luminaire	Off	Dimmer	0.0 %	Living room temperature	--- °C	Room air quality	819.84 ppm	Energy consumption heating	0 kWh	Energy consumption hot water	0 kWh
Datapoint	Value																
Ceiling lights	---																
Free-standing luminaire	Off																
Dimmer	0.0 %																
Living room temperature	--- °C																
Room air quality	819.84 ppm																
Energy consumption heating	0 kWh																
Energy consumption hot water	0 kWh																
System information																	
Living room																	
Bedroom																	
Childrens room East																	
Childrens room West																	
Bathroom																	
Toilet																	
Basement																	

ETS issues an error message if you exceed the maximum entry length of 36 characters.

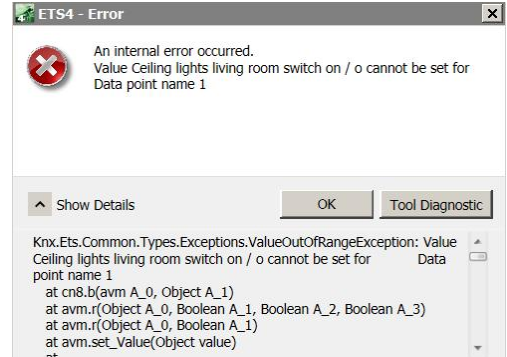

Data point types and sub-types

An appropriate data point type and sub-type is preselected based on the desired data point function.

Data point types

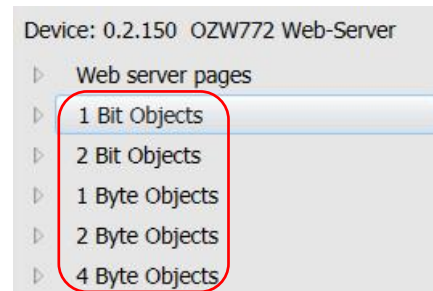

Data point sub-types

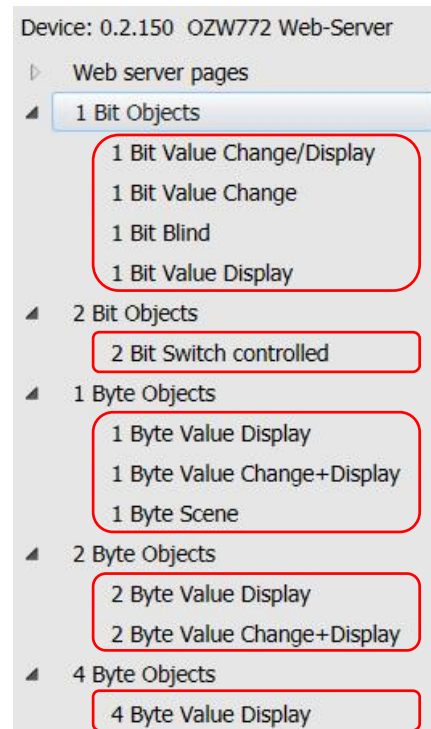

The data point sub-types are available in the following number:

Data point sub-types	No.	Data point numbers
1 bit value edit/display	40	8...47
1 bit value edit	20	48...67
1 bit value blinds	20	68...87
1 bit value display	20	88...107
2-bit switching controlled	5	108...112
1 byte value display	20	113...132
1 byte value edit/display	20	133...152
1 byte scene	5	153...157
2 byte value display	20	158...177
2 byte value edit/display	20	178...197
4 byte value display	40	198...237

A total of 237 data points are available, together with 7 standard data points (data point numbers 1...7).

ID/Name/Decoding

Each data point sub-type has an ID, a name, and a specific selection of possible settings (decoding).

Description of data point types

Below is a listing of all available data point types, data point sub-types, and possible settings.

System time and faults

Data point number 1...7: Standard data points

Number	Name	Object Function
1	System time	Receive / Transmit
2	Date	Receive / Transmit
3	Time of day	Receive / Transmit
4	Fault information	Transmit
5	Confirm faults	Receive
6	Fault state (normal/faulty)	Transmit
7	Fault transmission (enable/disable)	Receive

Setting for ID/Decoding is defaults on these data points:

Number/name	ID	Decoding
1: System time	19.001	Date / Time
2: Date	11.001	Date
3: Time of day	10.001	Time of day
4: Fault information	219.001	Alarm Info
5: Confirm faults	1.016	Confirm
6: Fault state (normal/faulty)	1.005	Alarm
7: Fault transmission (enable/disable)	1.003	Release

All following data points

The following setting options are available on all following data point types:

- A data point is **Enabled/disabled** via the setting option alongside "Value xx"



- A data point is assigned a **page** via the setting option "Web Server page"



- A **name** is assigned to a data point in the field "data point name", e.g. instead of the default name "Data point type/one-up number"

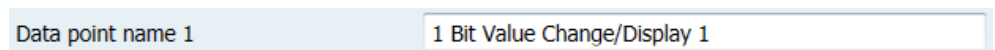

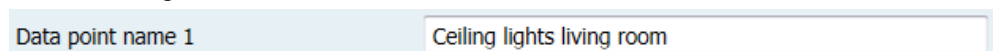

- A meaningful name such as



1 bit data points

Data point numbers 8...47: Change/display value 1...40"

 8	1 Bit Value Change/Display 1	Transmit
 9	1 Bit Value Change/Display 2	Receive

Uneven values are used for "edit"; even for "display".

Value 1 (Change)	Yes
Data point type	1.001 Off/On
Data point name 1	1 Bit Value Change/Display 1
Web server page	Page 1
Value 2 (Display)	Yes
Data point type	1.001 Off/On
Data point name 2	1 Bit Value Change/Display 2
Web server page	Page 1

Available settings for the data point type:

- 1.001 Off/On**
- 1.003 Disable/Enable
- 1.008 Up/Down
- 1.009 Open/Closed
- 1.018 Unoccupied/Occupied

Data point numbers 48...67: "Change value 1...20"

 48	1 Bit Value Change 1	Transmit
--	----------------------	----------

Value 1 (Change)	Yes
Data point type	1.001 Off/On
Data point name 1	1 Bit Value Change 1
Web server page	Page 1

Available settings for the data point type:

- 1.001 Off/On**
- 1.002 False/True
- 1.003 Disable/Enable
- 1.005 No Alarm/Alarm
- 1.006 Low/High
- 1.007 Decrease/Increase
- 1.008 Up/Down
- 1.009 Open/Closed
- 1.010 Stop/Start
- 1.017 Trigger
- 1.018 Unoccupied/Occupied

Data point numbers 68...87: "Blinds 1...20"

 68	1 Bit Blind 1	Transmit
Value 1 (Change)	Yes	
Data point type	1.008 Up/Down	
Data point name 1	1 Bit Blind 1	
Web server page	Page 1	

Available settings for the data point type:

- 1.007 Decrease/Increase**
- 1.008 Up/Down

Data point numbers 88...107: "Display value 1...20"

 88	1 Bit Value Display 1	Receive
Value 1 (Display)	Yes	
Data point type	1.001 Off/On	
Data point name 1	1 Bit Value Display 1	
Web server page	Page 1	

Available settings for the data point type:

- 1.001 Off/On**
- 1.002 False/True
- 1.003 Disable/Enable
- 1.005 No Alarm/Alarm
- 1.006 Low/High
- 1.009 Open/Closed
- 1.011 Inactive/Active
- 1.018 Unoccupied/Occupied
- 1.019 Closed/Open

2 bit data points

Data point numbers 108...112: "Switching controlled 1...5"

 108	2 Bit Switch controlled 1	Transmit
Value 1 (Change)	Yes	
Data point type	2.001 Off/On controlled	
Data point name 1	2 Bit Switch controlled 1	
Web server page	Page 1	

Available settings for the data point type:

- 2.001 Off/On controlled**
- 2.008 Up/Down controlled

1 byte data points

Data point numbers 113...132: "Display value 1...20"

113	1 Byte Value Display 1	Receive
Value 1 (Display)	Yes	
Data point type	5.001 Percentage (0..100 %)	
Data point name 1	1 Byte Value Display 1	
Web server page	Page 1	

Available settings for the data point type:

- 5.001 Percentage (0..100 %)
- 5.004 Percentage (0..255 %)
- 5.010 Value (0..255)
- 6.001 Percentage (-128..127 %)
- 6.010 Value (-128..127)
- 20.002 Building Mode
- 20.003 Occupancy Mode
- 20.102 HVAC Mode
- 20.103 DHW Mode
- 20.105 HVAC Control State
- 20.107 Changeover Mode

Data point numbers 133...152: 1 "Value change+display 1...20"

133	1 Byte Value Change+Display 1	Receive and Transmit
Value 1 (Change+Display)	Yes	
Data point type	5.001 Percentage (0..100 %)	
Data point name 1	1 Byte Value Change+Display 1	
Web server page	Page 1	

Available settings for the data point type:

- 5.001 Percentage (0..100 %)
- 5.004 Percentage (0..255 %)
- 5.010 Value (0..255)
- 6.001 Percentage (-128..127 %)
- 6.010 Value (-128..127)
- 20.002 Building Mode
- 20.003 Occupancy Mode
- 20.102 HVAC Mode
- 20.103 DHW Mode
- 20.105 HVAC Control State
- 20.107 Changeover Mode

Data point numbers 153...157: "Scene 1...5"

 153	1 Byte Scene 1	Transmit
Value 1 (Change)	Yes	
Data point type	18.001 Scene Control	
Data point name 1	1 Byte Scene 1	
Web server page	Page 1	
Scene Number	1	

Available settings for the data point type:

18.001 Scene Control

The field "Scene number" defines which scene number [1...64] is affected by the command.

1
1
2
3
4
5
6

2 byte data points

Data point numbers 158...177: "Display value 1...20"

 158	2 Byte Value Display 1	Receive
Value 1 (Display)	Yes	
Data point type	7.001 Value (0..65535)	
Data point name 1	2 Byte Value Display 1	
Web server page	Page 1	

Available settings for the data point type:

7.001 Value (0..65535)

- 7.005 Time (s)
- 7.006 Time (min)
- 7.007 Time (h)
- 7.013 Brightness (lux)
- 8.001 Value (-32768..32767)
- 9.001 Temperature (°C)
- 9.002 Temperature difference (K)
- 9.004 Brightness (lux)
- 9.005 Speed (m/s)
- 9.006 Pressure (Pa)
- 9.007 Humidity (%)
- 9.008 Air Quality (ppm)
- 9.022 Power Density (W/m²)
- 9.024 Power (kW)
- 9.025 Volume Flow (l/h)
- 9.027 Temperature (°F)

Data point numbers 178...197: "Value change+display 1...20"

178 2 Byte Value Change+Display 1 Receive and Transmit

Value 1 (Change+Display)	Yes
Data point type	7.001 Value (0..65535)
Data point name 1	2 Byte Value Change+Display 1
Web server page	Page 1

Available settings for the data point type:

- 7.001 Value (0..65535)
- 7.005 Time (s)
- 7.006 Time (min)
- 7.007 Time (h)
- 7.013 Brightness (lux)
- 8.001 Value (-32768..32767)
- 9.001 Temperature (°C)
- 9.002 Temperature difference (K)
- 9.004 Brightness (lux)
- 9.005 Speed (m/s)
- 9.006 Pressure (Pa)
- 9.007 Humidity (%)
- 9.008 Air Quality (ppm)
- 9.022 Power Density (W/m2)
- 9.024 Power (kW)
- 9.025 Volume Flow (l/h)
- 9.027 Temperature (°F)

4 byte data points

Data point numbers 198...237: "Display value 1...40"

198 4 Byte Value Display 1 Receive

Value 1 (Display)	Yes
Data point type	12.001 Value (unsigned)
Data point name 1	4 Byte Value Display 1
Web server page	Page 1
Metering medium	Heat and cooling energy
Identification number	12345678

Available settings for the data point type:

- 12.001 Value (unsigned)
- 13.001 Value (signed)
- 13.010 Energy (Wh)
- 13.013 Energy (kWh)
- 14.019 Electric Current (A)
- 14.027 Electric Potential (V)
- 14.031 Energy (J)
- 14.036 Heat flow rate (W)
- 14.056 Power (W)
- 14.065 Speed (m/s)
- 14.068 Temperature (°C)
- 14.076 Volume (m3)

For energy meters, the same data type must be used as specified by the producer for display purposes. This is the only way to avoid a loss in accuracy on large numbers, since large floating point numbers it is rounded off to the next displayable value.

Data points for types 12.xxx, 13.xxx and 14.xxx are labeled with the definition of the counter medium as energy meter. So that the following data is written once a day to the consumption data file. See sections:

- Meter medium.
- Identification number.

Data point value

"Meter medium" defines what is actually measured:

Other
 Oil
 Electricity
 Gas
 Heat (outlet)
 Steam
 Hot water
 Cold water
 Heat cost allocator
 Compressed air
 Cooling energy (outlet)
 Cooling energy (inlet)
 Heat (inlet)
 Heat and cooling energy

A unique identification number of the meter used (0 - 99999999) is entered under "Identification number".

Identification number 12345678

Communication properties of data points

Data points can have various communication properties. They are defined in KNX as flags. The flags can be unset (0) or set (1).

Flag	Meaning	Description (for set flag = 1)
C	Communications	Communication is possible via the bus.
R	Read	The data point can be read via the bus.
W	Write	The data point can be described via the bus.
T	Transfer	A change in data point is sent via the bus.
U	Refresh	The data point can be updated by other participants.

Flags are preset on participating devices/actuators/sensors. Some examples of typical communication properties:

Device function	Set flags
Displays (state, e.g. room temperature)	C W T U
Send (trigger, e.g. light switch)	C T
Send + display (state + trigger, e.g. heating setpoint).	C R W T U

Data exchange via group addresses

Example

Data points must be connected in order to exchange them. This occurs in ETS via the group address pane.

The room unit in the living room transmits its room temperature actual value to the Web Server OZW so that it is available there for the trend function and display of the plant diagram.

Procedure

A group is created in the ETS where the two data points are connected to one another. In this case, desirable:

- Main group: **Heating**
- Center group: **Actual values**
- Subgroup: Living room

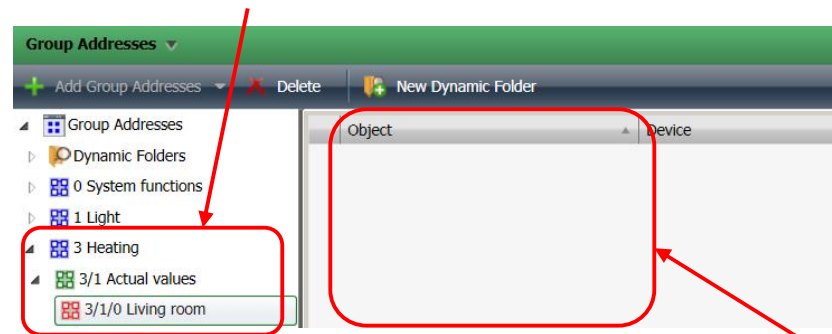

No objects (data points) are displayed in the pane for subgroup "Living room" since no data points have been linked with this group address.

First, select the desired room unit (QMX3.P37) from the device list. Left click data point "1: Room temperature [°C] – Transmit" to drag it to the empty pane.

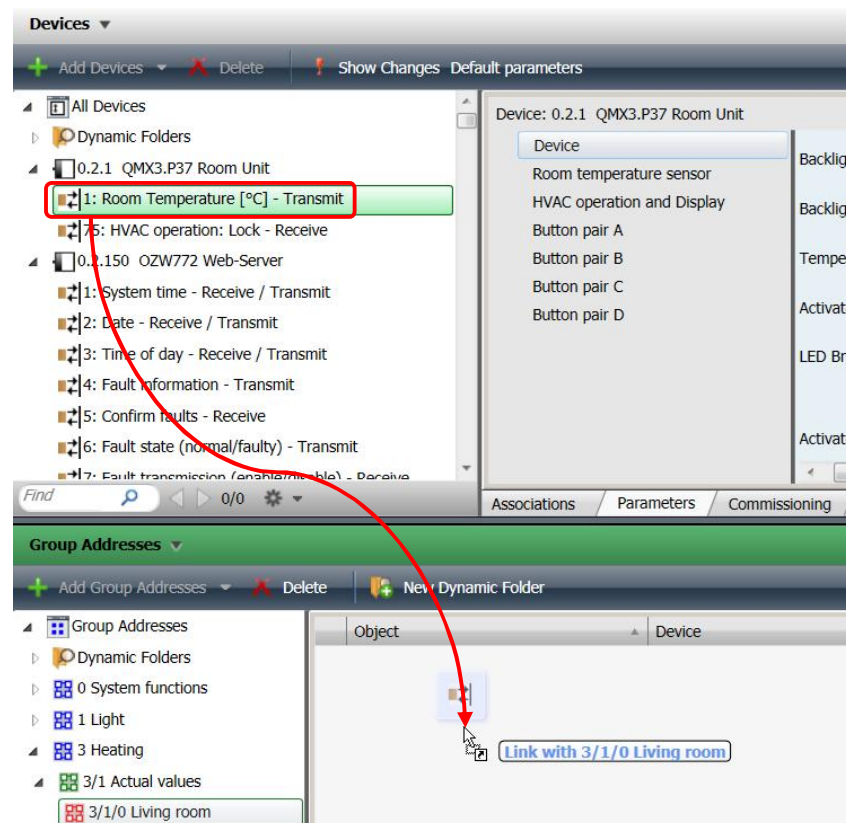

The data point is now linked to the group address "Living room" and added to the list of object.

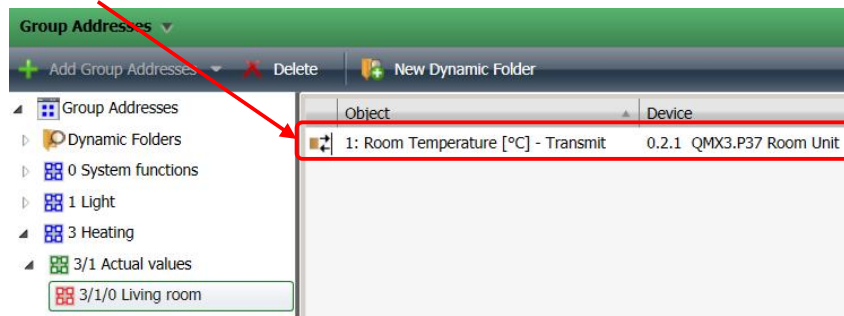

An available 2-byte data point is required to display a temperature in OZW. It is select from the ETS device list under "OZW772... Web Server" and defined.

Select "9.001 temperature (°C)" as the data point type.

Furthermore, the data point should be names in a meaningful manner and assigned a page on the Web Server. In this case, page 2, which was defined as the living room when the page name was issued.

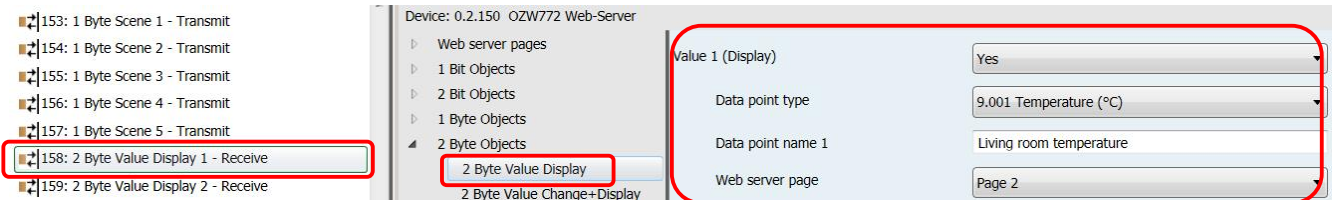

The data point is now dragged to the group address:

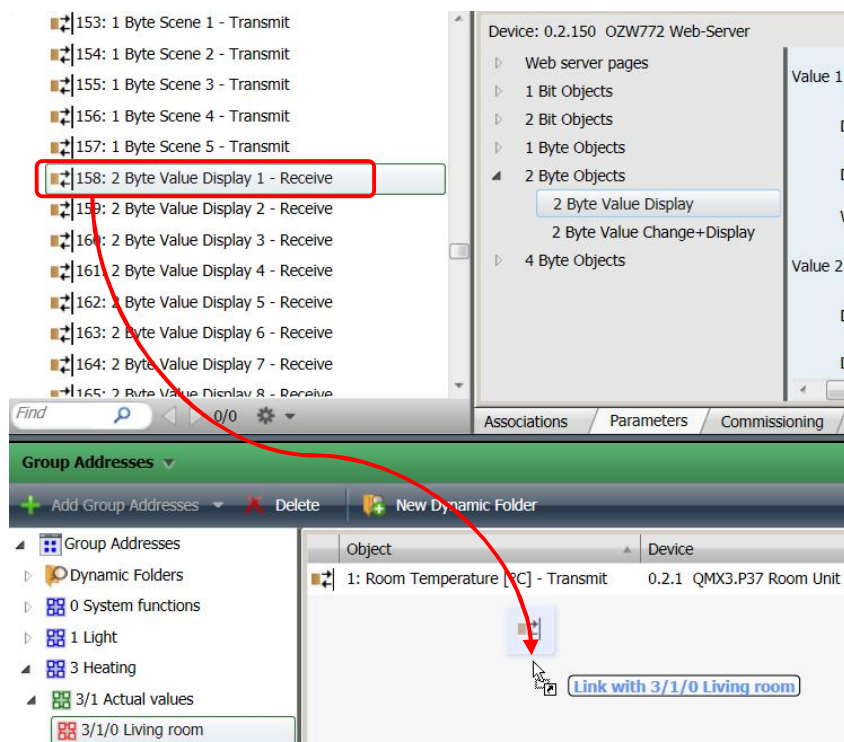

Result

Both data points are now linked to the group address "Living room" and added to the list of object.

The room unit sends its measured temperature which is received by OZW.

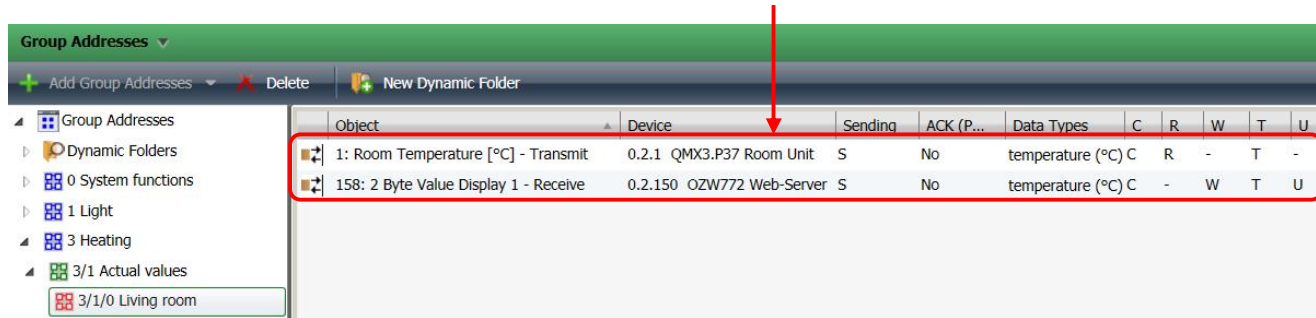

The screenshot shows the 'Group Addresses' window in ETS. The left sidebar shows a tree view with '3/1 Actual values' expanded to '3/1/0 Living room'. The main table lists two objects:

Object	Device	Sending	ACK (P...	Data Types	C	R	W	T	U
1: Room Temperature [°C] - Transmit	0.2.1 QMX3.P37 Room Unit	S	No	temperature (°C)	C	R	-	T	-
158: 2 Byte Value Display 1 - Receive	0.2.150 OZW772 Web-Server	S	No	temperature (°C)	C	-	W	T	U

Transmit project data

When transmitting the project or portions of the project from ETS to the devices on the bus, all the changes are saved on the applicable devices.

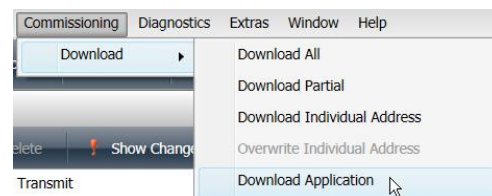

The various possibilities are described in the ETS documentation.

When ETS is connected to the KNX bus via OZW, ETS has the KNX address 15.15.254.

By configuring the OZW with ETS, the default group addresses are overwritten by system time and faults.

Update transmitted project data in OZW

The device stats of changed devices is no longer up-to-date after transmitted project data from ETS to the OZW.

OZW must be selected and updated with "Generate". Administrator or service user rights are required.

	Device name	Device address	Device type	Serial no	State	Generated on
<input type="checkbox"/>	OZW772.250	0.2.150	OZW772.250	00FD00FF2A11	Not updated	09.04.2014 15:38
<input type="checkbox"/>	QAX913	0.2.200	QAX913-9	00FD000BD0D1	Generated	03.04.2014 15:23

Add Delete **Generate** Hide

Device web pages

Process running: Device 1 from 1

Process takes a few minutes

Confirm with "OK".

Device web pages

Process finished

OZW is now updated.

	Device name	Device address	Device type	Serial no	State	Generated on
<input type="checkbox"/>	OZW772.250	0.2.150	OZW772.250	00FD00FF2A11	Generated	14.05.2014 14:37
<input type="checkbox"/>	QAX913	0.2.200	QAX913-9	00FD000BD0D1	Generated	03.04.2014 15:23

Add Delete Generate Hide

The changes can now be viewed in the menu tree.

The following changes are recognized and displayed on the device list as "Not updated":

- Writing and entire project
- Write a project without changes
- Add / delete /rename KNX pages.
- Add /Delete /Change type/Rename data points.

10.2 Operation KNX S-mode

Privileges

All KNX pages and S-Mode data points are access as of end-user level.

Page display in OZW772...

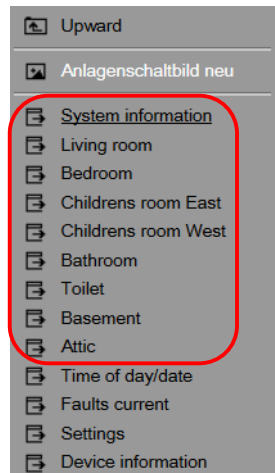

Home > 0.2.150 OZW772.250 >
Properties | + Ne

The pages defined via ETS are displayed in OZW772... in the secondary navigation between "New plant diagram" and "Time/date".

Only defined pages are displayed. For example, only 5 entries are located in secondary navigation is only 5 pages were defined.

ETS takes over page names and they cannot be changed in OZW. Changing the user language on OZW does not affect these texts.

Data point display

All data points defined to in ETS and assigned as page are displayed in OZW. The following example has all data points for page "Living room":

Datapoint	Value
Ceiling lights	---
Free-standing luminaire	Off
Dimmer	0.0 %
Living room temperature	--- °C
Room air quality	819.84 ppm
Energy consumption heating	0 kWh
Energy consumption hot water	0 kWh

ETS takes over data point names and they cannot be changed in OZW. Changing the user language on OZW does not affect these texts.

The data points are listed in the sequence of data point main types and within this list, in the engineering sequence.

Enter values

A pencil is displayed after the value on data points that can be edited. Click the symbol to show the associated operating dialog.

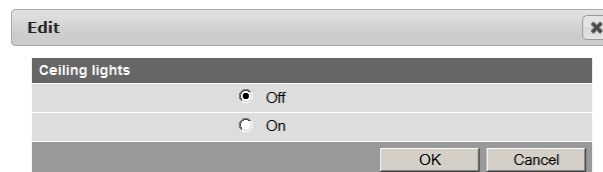

The value is sent over the bus to the defined S-Mode address by clicking the value and confirming it with "OK", even if the value has not changed. "Cancel" cancels the operating dialog and not value is sent over the bus.

The dialog depends on the type of data point. Here is an example for air quality:

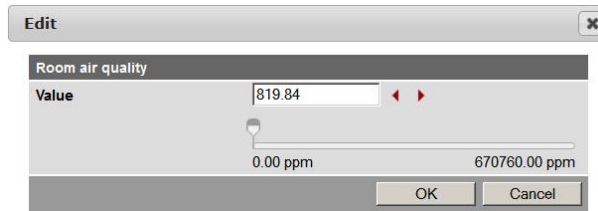

Dynamic display

The value is displayed as is the pencil depending on the type of data point.

Display examples	Data point type
---	Send
0.0 %	Displays
819.84 ppm	Send and display

- The value for the send data points is displayed as "- - -". The setting values are accessed by opening the operating dialog via the pencil symbol, as illustrated in the example for "ceiling lighting". The value is sent, but the displayed remains fixed on "- - -".
- Only the present data point value is displayed on display data points (i.e. no pencil symbol).
- For send and display data points, both the present value as well as the pencil symbol are displayed.

"- - -" is also displayed if the value for the displayed data point has not yet been read.

Plant diagram, trending, and access via web services

As soon as a transmitted ETS project is updated with "Generate" on OZW, the S-Mode data points are available for customized plant diagrams, trending, and access via web services (Web API).

Some data points are not available for trending and are hidden automatically when selecting the trend definition.

Behavior at restart

After a restart of OZW, a query is made for each display data point as soon as the Web Server accesses it the first time. OZW sends a second query if it does not get a response to the first one. The value is displayed as "- - -" as long as not response is received.

OZW772... does not detect as loss of KNX bus power and a subsequence restart to KNX communications. In other words, the old display value remains until the next change of value.

COV

Each change of value (COV, Change Of Value) to a send data point (or send/display data point) is sent over the bus. Regardless of whether the change is local on the OZW or was made via the web interface. The value is sent as soon as the setting is confirmed with "OK", even if the actual value was not adjusted.

Heartbeat

Communication on and over the KNX bus is event-controlled. The data points have no heart beat as a rule.

Default KNX subtype

Data points can be defined in ETS that are not explicitly supported by OZW. OZW converts any such data points received from ETS into its default subtypes.

KNX main type	Default KNX subtype	Name and decoding
1.*	1.001	Switching (Off/On)
2.*	2.001	Prio. switching (Off/On controlled)
5.*	5.001	Percent (0...100%)
6.*	6.001	Percent (-128...127%)
7.*	7.001	Value (0...65535)
8.*	8.001	Value (-32768...32767)
9.*	9.001	Temperature (-273...670 760 °C)
12.*	12.001	Value (unsigned 0...4 294 967 295)
13.*	13.001	Value (signed -2 147 483 648...2 147 483 647)
14.*	14.019	Current (A).
18.*	18.001	Scene control (Scene control: Call up/memorize scene number)
20.*	20.002	Building mode (building operating mode: Building used, building not used, building protection)

* = unsupported subtype from this main type group

11 Appendix

11.1 General notes

Text entry

Names of data points and message text, e.g. of faults, cannot contain special characters or umlauts. Valid characters:

- a...z and A...Z
- 0...9
- ! „ \$ % & , () * + ` - . / : ; < = > ? "Space

Note

 When sent, **invalid characters** will be converted to "?" (question marks).

11.2 Diagnostics

11.2.1 Web Server fault codes

Fault codes

Fault code	Web Server fault	Type of fault
General		
0	No fault	No acknowledgement
1	Plant ok	No acknowledgement
2	Fault	No acknowledgement
3	No urgent fault	No acknowledgement
Communications		
5000	No bus power supply	No acknowledgement
5001	System time failure (Web Server as slave)	No acknowledgement
5002	>1 clock time master	With acknowledgement
5003	Invalid time of day (Web Server time not or incorrectly entered)	No acknowledgement
5012	Device failure (Bus) *	No acknowledgement
5023	Message receiver 1 not reached	No acknowledgement
5024	Message receiver 2 not reached	No acknowledgement
5025	Message receiver 3 not reached	No acknowledgement
5026	Message receiver 4 not reached	No acknowledgement
5027	Consumer receiver 1 not reached	No acknowledgement
5028	Consumer receiver 2 not reached	No acknowledgement
5029	Energy ind. receiver 1 not reached	No acknowledgement
5030	Energy ind. receiver 2 not reached	No acknowledgement
5034	Trend receiver 1 not reached	No acknowledgement
5035	Trend receiver 2 not reached	No acknowledgement
System configuration errors		
6001	>1 identical device address (Devices have same address)	With acknowledgement
7001	Change local Admin'password	No acknowledgement

* Device failure (bus) is a fault generated by the Web Server for a failed device. As result, the device failure (bus) is assigned to "System faults", whereas all other faults generated by the Web Server are assigned as "Local faults".

11.2.2 Windows Commander

Windows Commander

You can use the Windows Commander to check availability of IP addresses, domains or servers:

1. Open Windows commander: *Start > Run*.
2. Enter "cmd".

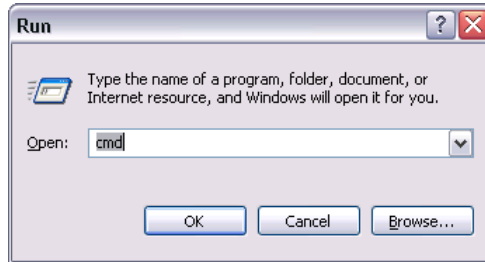

3. Click [OK]
4. Enter the desired command in the command line C:\>:

Command	Result, application
ping <IP address> or <domain>	Response times to the query: Checks whether an IP address can be reached in the network.
Tracert <IP address> or <domain>	Progress of the IP address implementation to the goal: Check whether DNS and mail servers can be reached.
nslookup <IP address> or <domain>	Translates an IP address to the domain name and vice versa: Look up domain names.

11.3 Communications

11.3.1 Internet protocol

Private networks

The following IP addresses are reserved for private networks:

- Class A: 10.0.0.0–10.255.255.255.
- Class B: 172.16.0.0–172.31.255.255.
- Class C: 192.168.0.0–192.168.255.255 (typical for home networks).

Ports

There are predefined public ports and ranges for private ports:

Web browser	http (recommended only on private network)	80
	https (recommended on public network)	443
ACS Tool	ACS Tool	50005
	Offline Trend and FTP	21
ETS Tool	ETS Tool	3671

Note



Access by ACS or ETS to Web Server is only temporary for security reasons. Continuous access can only be set up on a separated local network (e.g. for operate /& Monitor via KNXnet/IP).

11.3.2 Free e-mail account providers

You can use free-of-charge e-mail accounts to send e-mails. Note that some ISPs work with encryption or can be accessed and used only via the Web Server's DSL connection.

Note



The following list is not conclusive, ISPs are subject to change.

Free e-mail account providers				
	Address mail server	Port mail server	Authentication	Restriction
GMX	mail.gmx.net	25, 587	Yes	
Google Mail	smtp.gmail.com	587	Yes	TLS required
Hotmail	smtp.live.com	587	Yes	TLS required
Yahoo! Mail	smtp.mail.yahoo.com	25, 587	Yes	

Additional information on free e-mail providers:

- http://www.patshaping.de/hilfen_ta/pop3_smtp.htm
- <http://www.iopus.com/guides/bestpopsmtpt.htm>

Note



Siemens is not responsible for the content of external pages.

11.3.3 Install RNDIS driver

RNDIS driver

The PC requires a USB RNDIS driver for the connection between the PC and the Web Server. Windows hardware recognition recognizes the Web Server when the USB cable is plugged into the USB cable. You can start the Add Hardware Wizard if no RNDIS driver is installed.

The driver is installed in the background with an Internet connection as long as the online update service is enabled by the network administrator. You can install the driver manually without an Internet connection.

Note

 The operating system must be equipped with the latest updates.

Automatic installation

Procedure:

1. Select "Search for and install the hardware automatically (Recommended)".



2. Click [Next >]
The software is installed.
3. Confirm hardware installation:
Click [Continue installation]
4. Wait until installation is complete and click [Finish]



Result

The RNDIS driver is now installed. The PC can communicate with the Web Server via USB.

Manual installation

The RNDIS driver is supplied on the Web Server at <http://<IP-Adresse>/drivers/> can be accessed via Ethernet connection (see Section 8.1.2, Access via Local area network (LAN)).

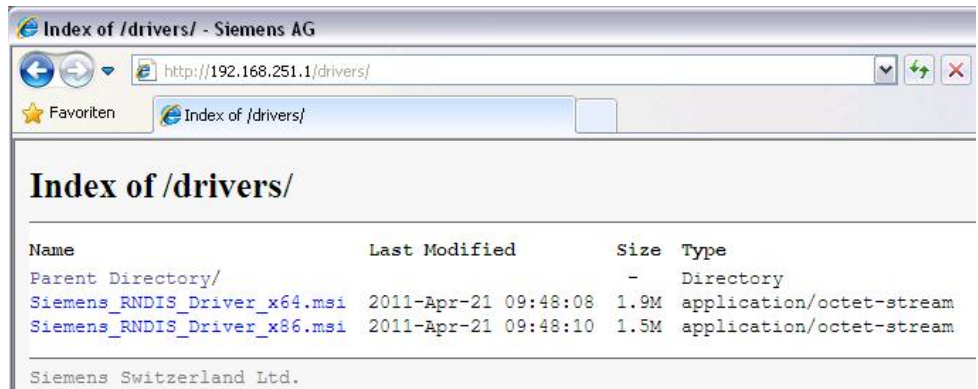

The driver [Siemens RNDIS Driver x64.msi](#) is installed on a 64-bit operating system; on a 32-bit operating system [Siemens RNDIS Driver x86.msi](#). The installation file for the driver can be executed directly on the PC. Following the steps for the installation wizard.

Result

The RNDIS driver is now installed.
The PC can communicate with the Web Server via USB.

Note



The RNDIS driver is installed as part of the ACS790 Siemens software installation.

11.3.4 Alternative network configuration

Alternative configuration

We recommend setting up IP settings for commissioning as an alternative configuration if a PC, connected to a network, is temporarily used to commission the Web Server and the local area network.

On the PC, set as follows:

1. Select *Start > Control Panel > Network connections > Local Area Connection*.
2. Select the "General" tab.

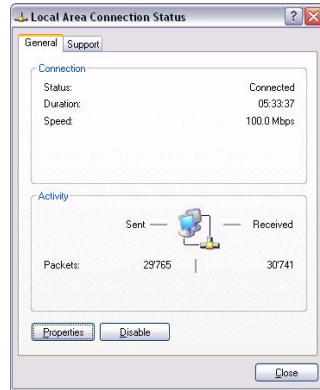

3. Click [Properties]
4. Select "Internet Protocol (TCP/IP)".

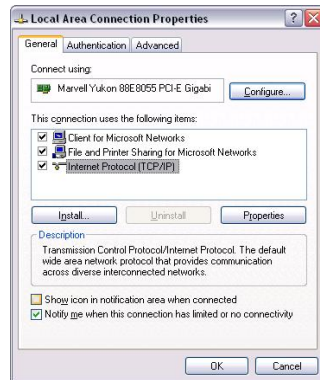

5. Click [Properties]
6. Select "Alternate Configuration" tab.
7. Enter IP address, subnet mark and operational standard gateway as well as DNS server.

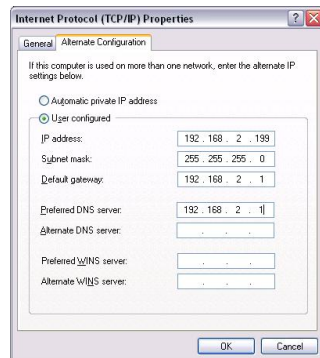

Result

The PC assumes the configuration with these settings as soon as it is no longer integrated in the standard network.

11.4 Glossary of Ethernet and Internet terms

ADSL	<p>Upstream and downstream channel transport data at different rates, i.e. asymmetrically via a two-wire line (DLS, copper phone line) on a broadband network.</p> <p>Very little data is sent upstream, i.e. to the server, when surfing. The requested data, however, are sent at high speed downstream to the requesting computer. You can call or e.g. send faxes while transmitting data.</p> <p>The Internet Service Provider ISP provides the ADSL connection. You need a DSL modem for this type of connection.</p>
Asymmetrical Digital Subscriber Line	<p>see <i>ADSL</i>.</p>
Bit rate	<p>The bit rate describes the transmission speed or rate in bits per second (bps).</p>
Broadcast	<p>Data sent out to all participants on the network.</p>
Client	<p>A client is a network device unable to execute certain services and thus requests those services from the server. The server provides the service and sends a reply.</p>
Default gateway	<p>Gateway that is selected when one IP address is outside its own subnet and therefore the standard gateway is unknown.</p>
DHCP	<p>The new Dynamic Host Configuration Protocol allows for dynamic allocation of a network configuration to clients (PC, Web Server) via a server (router).</p>
Digital Subscriber Line	<p>see <i>DSL</i>.</p>
DNS	<p>The DNS allows for assigning IP addresses to names (that are easier to remember than 32-bit IP addresses). A DNS server must manage this information for each LAN with Internet connection. When you select an Internet page, the web browser accesses the IP address for that site assigned by the DNS server to open a connection.</p> <p>On the Internet, domain names are assigned to IP addresses as per a hierarchical system. A local PC only knows the address of the local DNS server. This server, in turn, knows the addresses of all PCs on the local network as well as that of the higher DNS servers that, in turn, know the addresses of the next higher DNS servers.</p>
Domain Name System	<p>see <i>DNS</i></p>
Domain name	<p>The domain name is the Web Server designation on the Internet. The DNS server assigns an IP address to the domain name.</p>
DSL	<p>DSL is a type of data transmission allowing for 1.5 Mbps access to the Internet on standard copper phone lines. The Internet Service Provider ISP provides the DSL connection. You need a DSL modem for this type of connection.</p>

DSL router	The DSL router has several functions. It connects the Ethernet network (LAN) and the internal network devices to the Internet. The router then requests the IP addresses for the internal network devices from the DNS server. Port forwarding (NAT, PAT) is also configured in the router. In addition, service "Dynamic DNS" which automatically is updated after a change of the Dynamic DNS server, is activated in the router.
Dynamic DNS	<i>see DynDNS.</i>
Dynamic Host Configuration Protocol	<i>see DHCP.</i>
Dynamic IP address	<p>A dynamic IP address is assigned automatically via DHCP to a network device. As a result, the IP address for a network device differs every time the device logs in or at periodic intervals.</p> <p>The ISP assigns dynamic IP addresses to network devices that are not online continuously, i.e. integrated in the network. Dynamic IP addresses are reassigned to other devices, as the number of addresses is limited. Web Server (permanently online) does not use a dynamic IP address.</p>
DynDNS	Dynamic DNS is a widely used Dynamic DNS service.
Dynamic DNS	<p>The DNS server assigns domain names and IP addresses. Dynamic DNS is needed for dynamic IP addressing. It allows deployment of a network device with dynamic IP address on the Internet.</p> <p>Dynamic DNS ensures that a service is always available on the Internet under the same domain name regardless of the current IP address.</p> <p>A domain name can be registered with a Dynamic DNS service.</p>
Ethernet	Ethernet is a network technology for local networks (LAN). Ethernet operates at a transmission rate of 10 or 100 Mbps and has a maximum range of 100 meters between two network components.
Firewall	<p>A firewall protects networks against unauthorized access from the outside. Firewalls are hardware and/or software measures designed to control data exchange between the private network to be protected and an unsecured network (e.g. the Internet).</p>
Gateway	A gateway is a device connecting networks of different architecture (addressing, protocols, interfaces, etc.). Although not entirely correct, the term often is used interchangeably with router.
HTTP proxy	A proxy is a server used by network devices for Internet traffic. All requests are sent via the proxy server.
HTTPS	The Web Server supports HTTPS (Hyper Text Transfer Protocol Secure).
Hub	A hub in a star-topology network connects various network devices by receiving all data from one device and forwarding it to other devices.

Hyper Text Transfer Protocol Secure	<i>see HTTPS.</i>
Internet	<p>The Internet is a data network with millions of members. A number of protocols are used to exchange data, summarized under the term TCP/IP.</p> <p>All devices connected to the Internet can be identified via IP address. The DNS server assigns domain names to IP addresses.</p>
Internet Protocol	<i>see IP.</i>
Internet Service Provider	<i>see ISP.</i>
IP	<p>The IP protocol is a TCP/IP protocol. It is responsible for addressing devices on a network based on IP addresses and transmitting data packages from sender to Receiver. The IP protocol determines the order and network connection used to send data packages (routing).</p> <p>The transmission control protocol TCP reassembles the data packages in the right order at the Receiver.</p>
IP address	<p>The IP address is a unique address of a network device on the network based on TCP/IP protocols. The IP address consists of four sections, separated by a dot (192.168.1.1).</p> <p>The IP address comprises the network number and the computer number (number of the network device). Depending on the subnet mask, one, two or three portions form the network or computer number.</p> <p>IP addresses can be assigned automatically or manually. On the Internet, domain names are used rather than IP addresses. The DNS server assigns domain names to IP addresses.</p>
IP address pool	IP address pool defined at the router (IP address range) the DHCP server can be used to assign dynamic IP addresses.
LAN	A local network (size: large building, building sites) is a number of interconnected network devices. In LANs, data is exchanged and resources are used jointly. A LAN can be connected to other networks such as WAN or Internet.
Local Area Network	<i>see LAN.</i>
MAC address	The MAC address allows for worldwide identification of a network adapter (network card). It consist of hexadecimal numbers, grouped in six portions at 2x4 bit each, thus 48 bit, e.g. 00-55-96-5D-00-2C. The MAC address is assigned by the network adapter manufacturer and cannot be changed.
Mbps	Million bits per second indicates the transmission rate in a network.
Media Access Control	<i>see MAC address.</i>

NAT	<p>NAT is a method to translate IP addresses (private IP addresses) in a network into one or several public IP addresses on the Internet. NAT allows us to use several network devices in a LAN together with a public IP address of a router for Internet access.</p> <p>The network devices of the local network are masked by the IP address (router) registered on the Internet. Thanks to this security function, NAT often is used as a part of a network's firewall. Web Server is accessible from a public network thanks to the correct NAT table definition; see also port forwarding.</p>
Network	A network (LAN, WAN) is a linked group of devices connected via various lines or radio sharing common resources such as data or peripheral devices.
Network adapter	Hardware to connect network components to a local area network (LAN). Connection can be wired or wireless.
Network Address Translation	See <i>NAT</i> .
Network configuration	All settings an IP-based device requires to work on a network: IP address, subnet mask, standard gateway, preferred DNS server, and alternate DNS server.
PAT	PAT or NPAT (Network and Port Address Translation) translates all private network addresses into one public (dynamic) IP address. In this process, port numbers are exchanged in addition to addresses when there is a connection. As a result, an entire private network only requires one single registered public IP address.
Plant room	The ISP provides the connection to the Internet via DSL or cable TV (at a fee).
Point-to-Point Protocol	See <i>PPP</i> .
Port	<p>Ports are used to exchange data between different applications on a network. The port number addresses the application within a network device. The combination of IP address and port number serves as a unique identification of the Receiver or the sender of the data package with the network.</p> <p>Internet service applications work with set port numbers (HTTP 80, FTP 21). See http://www.iana.org/assignments/port-numbers for registered port numbers. Port numbers 0 to 49151 are set and reserved, port numbers 49152 to 65535 are dynamic (and therefore available).</p>
Port and Address Translation	See <i>PAT</i> .
Port Forwarding	<p>With port forwarding, the router forwards data packages from the Internet, destined for a particular port, to the port of the responsible network device. As a result, servers (Web Server) integrated in a LAN, can be reached from the Internet (without a need for a public IP address). Port Forwarding is achieved by the correct NAT / PAT definition in the router.</p>
PPP	Protocol for dial-up connection of a computer to the ISP.
PPP over Ethernet	See <i>PPPoE</i> .

PPPoE	Protocol used to connect to the Internet via ADSL or DSL.
Private IP address	<p>The private IP address (local IP address) is the address of a network device on a local network (LAN). The provider assigns this address at will. DSL routers have a public IP address for the WAN and a private IP address for the LAN. The following IP ranges are recommended for private IP addresses:</p> <p>10.0.0.0...10.255.255.255 → Class A. 172.16.0.0...172.31.255.255 → Class B. 192.168.0.0...192.168.255.255 → Class C.</p> <p>The first IP address xxx.xxx.xxx.0 and the last IP address xxx.xxx.xxx.255 in a network segment cannot be used, as xxx.xxx.xxx.0 is reserved for the network and xxx.xxx.xxx.255 for broadcasting.</p>
Protocol	A protocol describes the type of communication on a network. It contains rules on opening, managing, and closing a connection, on data formats, time sequences, and possible error correction. Different protocols are needed to allow two applications at different levels to communicate with each other, e.g. TCP/IP protocols on the Internet.
Provider	Provider of telecommunications services. Also referred to as network provider or network operator.
Public IP address	<p>The public IP address is the worldwide valid (global) address of a network device on the Internet. The ISP assigns these addresses. A network device with public IP address is a device establishing a connection between local network LAN and the Internet.</p> <p>DSL routers have a private IP address for the LAN and a public IP address for the WAN (Internet).</p>
RNDIS	Remote Network Driver Interface Specification. Protocol to generate a virtual Ethernet when communicating between the device and a computer via USB.
Router	A router forwards data packages from a local network LAN to a higher network while selecting the fastest route. A router allows for connecting different networks with different network topologies. For example, the router connects a local network to the Internet.
Secure Sockets Layer	See <i>SSL</i> .
Server	A server accepts requests from clients, processes them and responds to the clients. Network servers, data servers, Web Servers also assume services for other network devices.
Simple Mail Transfer Protocol	See <i>SMTP</i> .
SMTP	The SMTP protocol is a TCP/IP protocol. It controls e-mail traffic on the Internet. The ISP provides the SMTP server (mail server).
SSL	Outdated form for TLS; see TLS.
Standard gateway	A default gateway (see Default Gateway as well as DSL router) is also referred to as a network address used by clients to send their packages if the target address is outside the immediate network.

Static IP address	Network devices, and servers in particular, integrated permanently in a network, have static IP addresses. Clients often have a dynamic IP address. Web Server (integrated permanently in a network) has a static IP address and can thus be reached easily by clients.
Subnet	A subnet subdivides a network into smaller network segments.
Subnet mask	<p>A subnet mask masks the IP address, i.e. it determines which parts of the IP address form the network number and which parts the computer number (e.g. server).</p> <p>Subnet mask 255.255.255.0 means that the first three sections of the IP address determine the network number, and the fourth section is used for the computer number. In this case, the first three IP address sections are identical for all network devices. Example:</p> <p>Subnet mask 255.255.255.0 masks IP addresses: 192.168.1.1...192.168.1.254.</p> <p>Please note: Do not use the first IP address 192.168.1.0 and last IP address 192.168.1.255.</p>
Switch	A switch, similar to a hub, is a connecting element to connect various network segments or network devices. Contrary to the hub, a switch is an intelligent device used to route packages only to the subnet or network device for which a package is destined.
TCP	<p>The TCP protocol is a TCP/IP protocol. TCP is responsible for transporting data between two communication partners (applications). TCP is a secured transmission protocol, i.e. a connection is established, monitored and disconnected to data transmission.</p> <p>TCP is a so-called connection-oriented protocol. The transmission control protocol TCP reassembles the data packages, sent by the Internet protocol IP via different network connections, in the right order at the Receiver.</p>
TCP/IP	Family of protocols used as the basis for the Internet. TCP/IP for the basis for any number of internet services such as HTTP (Web), FTP (file transfer) and SMTP (mail).
TLS	<p>TLS (Transport Layer Security, for [outdated]: SSL Secure Sockets Layer) a hybrid encryption protocol to transmit data over the Internet. TLS 1.0, 1.1 and 1.2 are standardized developments of SSL 3.0 (TLS 1.0 is now used for SSL 3.1). In other words, SSL is being further developed under the name TLS.</p> <p>The Web Server always uses TLS for e-mails if the e-mail provider supports TLS.</p>
Transmission Control Protocol	See <i>TCP</i> .
Transport Layer Security	See <i>TLS</i> .
UDP	UDP is a TCP/IP protocol to control data traffic between two communication partners (application). UDP, in contrast to TCP, is an unsecured protocol. UCP is a so-called connection-less protocol. Data packets are broadcast. The Receiver is responsible for receiving data. The sender does not receive notification if the data packages were received.

Uniform Resource Locator	<i>See URL.</i>
Universal Plug and Play	<i>See UPnP.</i>
UPnP	UPnP technology was designed for home and office networks. Devices supporting UPnP automatically configure their network settings as soon as connected to a network. In addition, they automatically provide, depending on class, own services or use services of other devices on the network.
URL	A URL refers to an information source, e.g. http://www.siemens.com . The URL is a uniform web address that is used to determine the network protocol used (e.g. http) or the location of the resource on the network.
User Datagram Protocol	<i>See UDP.</i>
WAN	The wide area network WAN has a spatial dimension of ca. 50 km. A WAN can comprise a number of several LANs. If an ISP operates a WAN, private LAN users receive access to the Internet.
Wide Area Network	<i>see WAN.</i>
Wireless LAN	<i>see WLAN.</i>
WLAN	Wireless LANs allow network devices to communicate via radio. The WALN can be added as an extension to a wired LAN, or it can be the basis of a new network.

Index

1	
1 bit data points	146
1 byte data points	148
15.15.254	154
2	
2 bit data points	147
2 byte data points	149
4	
4 byte data points	150
A	
Abbreviations.....	13
ACS	
Continuous access	161
ACS trend.....	137
Activate Energy indicator function	
Data point monitoring.....	93
Activate plant.....	46
Address translation (NAT).....	111
Administer user accounts.....	18
Alternative network configuration	164
B	
Blind control.....	139
Bus load	124
C	
Commission router settings.....	37
Commissioning	
Additional settings	41
Create device web pages	20
Final steps.....	42
Functional check	39
Local area network	36
Local operator station	36
Log onto Web Server.....	16
Message receiver	28
Network components.....	36
Prerequisites	14
Settings.....	24
Turn on Web Server	15
Communication	
E-mail.....	114
Internet protocol	161
Private networks.....	161
Remote operation.....	105
Consumption data.....	32
COV	157
Create own plant web pages	69
D	
Data point address	121
Data point types	144
Data points.....	141
Date/time.....	23
Deactivate Energy indicator function	
Confirmation message	92
Data point monitoring.....	91
Green limits to default values	92
Monitoring off.....	92
Summary checkbox.....	92
Deep Link.....	50
Device Description	82
Device faults.....	56
Device information.....	53
Ethernet.....	54
KNX.....	53
Services.....	55
Device web pages	83
Diagnostics Web Server	53
Dialog box Energy indicator	
Comfort cooling setpoint.....	96
Comfort heating setpoint.....	96
Data point value	95
Enumeration data points.....	97
General.....	95
Numeric data points	96
Operating mode	97
Setting range	95
Variable unit data points	98
Display and operating elements.....	9
Dynamic DNS.....	113
E	
Edit data point address	135
E-mail	
Receiver	129
Test receiver	128
Transmission options	128
Transmit interval.....	129
Trend data	127
E-mail Energy indicator	
Configure E-mail receiver.....	101
Contents	103
Energy indicator of plant.....	101
Mailbox	102
E-mail Trend receiver	127
Energy indicator	
Green leaf.....	80

Grey leaf	80	Set values	156
Orange leaf	80	KNX devices	82
Summary display	89	KNX S-Mode	139
Temporary status	90		
Visibility	88	L	
Energy values	139	Language	24
ETS	141, 152	Levels Energy indicator function	
Continuous access	161	Data points	86
Example of a plant web page	64	Partial plants	85
		Plant	84
F		Lighting control	139
Fault codes	159	Local area network	110
Faults current	24	Login	49
Local	56	Logo update	43
System	57	Logout	50
Firewall	111		
Firmware Update	43	M	
Function Energy indicator		Message receiver	
Commissioning	90	Holidays/special days	30
Estimated processing time	91	Monday - Sunday, special day	29
Monitored data points and green limit(s)	80	Receiver type	28
Number of monitored data points	87	Message receivers	28
Quantity Energy indicator data points	81	Minimum password strength	17
User groups service and end user	100		
		N	
G		Notations	13
Group addresses	152		
		O	
H		Offline trend	137
Heartbeat	157	Operate the plant	51
HIT	67	Operate Web Server	51
Holidays/special days	30	Operate&monitor	63
Home network	110	Operating	
		File transfer	28
I		Operation	
Import		Bus device	51
Trend definition	134	Connect	49
Install RNDIS driver		Faults	56
Automatically	162	File transfer	58
Internet connection	110	Login	49
Invalid characters	159	Logout	50
		Overview	49
K			
KNX		P	
Data exchange	152	Password	16, 17
Data point display in OZW	156	Plant diagrams	67
Data point names	143	Plant roles	48
Data point types	144	Plant state Energy indicator	
Data points	141	Green leaf	89
Default subtypes	158	Orange leaf	89
Group addresses	152	Summary display	89
Interfaces	140	Plant web pages	63
Page display in OZW	156	Port forwarding (PAT)	112
Pages	142	Portal	
Plant diagram	139, 157	Access	44
Project data	154	Log in	46

Operating languages	45
Prevent access	48
Roles	48
Ports	161
Primary navigation	10
Private networks	161

R

Remote access via portal	44
Remote operation via the Internet	110
RNDIS driver	162

S

Scene control	139
Secondary navigation	10
Send messages	29
Services	28, 55
Set up portal access	44
Settings	
ACS access	28
Automatic log off	28
Communication	25
Consumption data	32
E-Mail	
Mailserver address	26
Mailserver port number	26
Sender e-mail address	26
Ethernet	
IP address, IP subnet address	26
ETS access via KNXnet/IP	28
Faults	34
Konnex	
Area, Line, Device address	25
Clock time mode Konnex	25
Remote setting clock slave Konnex	25
LPB / BSB	25
Message recipient 1...4	28
Portal connection	28
Services	28
Texts	35
UPnP localization	28
Web access via http	28
Web Server	24
S-mode	139
Software Updates	43
Standard applications	67
Start Function Energy indicator	90
Summary checkbox Energy indicator	92
Summary display Energy indicator	89
Supply state	43
Symbols	12
Synco IC	44
Synco range	82
System data update	43
System report	
Message cycle	31

Next report	31
Priority	31
Signal time	31

T

Text entry	159
Time of day/date	23
Time synchronization, Time zone	24
Timeout	50
Transmit project data	154
Tree leaf as Energy indicator	80
Trend	
ACS	137
Bus load ACS	138
Channel	128
Compatibility	137
Copy	136
Data points	125
Define	120
Download file	131
E-mail	127
Export	134
Graphical display	133
Import	134
Information	120
RAM	126
Reset	124
Transmission options	128
Transmit interval	128
Trend functions	119

U

Updates	43
UPnP localization	
USB	27
UPnP Localization	
Ethernet	28
User levels	11
User name	16, 17

V

Valid characters	159
Visibility Energy indicator	88
Visualize	63

W

Web operation, user interface	10
Web page	
Energy indicator function	81
Energy indicator update	90
Web Server	
Fault codes	159
Language	24
Web Server diagnostics	53
Web Server settings	23
Windows Commander	160

Siemens Switzerland Ltd
Building Technologies Division
International Headquarters
Gubelstrasse 22
6301 Zug
Switzerland
Tel. +41 41-724 24 24
www.siemens.com/buildingtechnologies

© Siemens Switzerland Ltd, 2009
Subject to change